

Smart choice for power

xantrex

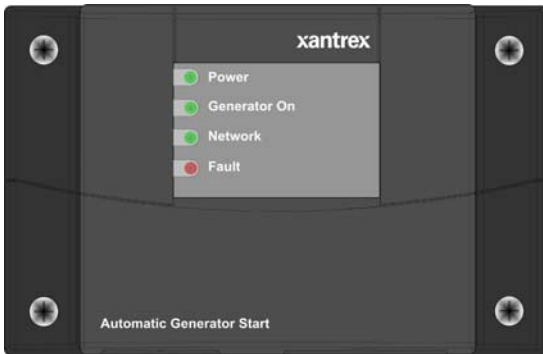

Owner's Guide

XW Automatic Generator Start



www.xantrex.com

XW Automatic Generator Start

Owner's Guide

About Xantrex

Xantrex Technology Inc. is a world-leading supplier of advanced power electronics and controls with products from 50 watt mobile units to 1 MW utility-scale systems for wind, solar, batteries, fuel cells, microturbines, and backup power applications in both grid-connected and stand-alone systems. Xantrex products include inverters, battery chargers, programmable power supplies, and variable speed drives that convert, supply, control, clean, and distribute electrical power.

Trademarks

XW Automatic Generator Start is a trademark of Xantrex International. Xantrex and Xanbus are registered trademarks of Xantrex International.

Other trademarks, registered trademarks, and product names are the property of their respective owners and are used herein for identification purposes only.

Notice of Copyright

XW Automatic Generator Start Owner's Guide © March 2007 Xantrex International. All rights reserved.

Disclaimer

UNLESS SPECIFICALLY AGREED TO IN WRITING, XANTREX TECHNOLOGY INC. ("XANTREX")

(a) MAKES NO WARRANTY AS TO THE ACCURACY, SUFFICIENCY OR SUITABILITY OF ANY TECHNICAL OR OTHER INFORMATION PROVIDED IN ITS MANUALS OR OTHER DOCUMENTATION.

(b) ASSUMES NO RESPONSIBILITY OR LIABILITY FOR LOSS OR DAMAGE, WHETHER DIRECT, INDIRECT, CONSEQUENTIAL OR INCIDENTAL, WHICH MIGHT ARISE OUT OF THE USE OF SUCH INFORMATION. THE USE OF ANY SUCH INFORMATION WILL BE ENTIRELY AT THE USER'S RISK.

Date and Revision

March 2007 Revision A

Part Number

975-0307-01-01

Product Number

865-1060

Contact Information

Telephone: 1 800 670 0707 (toll free North America)
1 360 925 5097 (direct)

Fax: 1 800 994 7828 (toll free North America)
1 360 925 5143 (direct)

Email: customerservice@xantrex.com

Web: www.xantrex.com

About This Guide

Purpose

The purpose of this Owner's Guide is to provide explanations and procedures for installing, operating, maintaining, and troubleshooting the XW Automatic Generator Start.

Scope

The Guide provides safety guidelines, detailed planning and setup information, procedures for installing the XW Automatic Generator Start, as well as information about configuring, operating and troubleshooting the unit. This guide does not provide information about choosing a generator or operating a generator.

Audience

The Guide is intended for anyone who needs to install and/or operate the XW Automatic Generator Start. Installers should be certified technicians or electricians.

Organization

This Guide is organized into five chapters and three appendixes.

Chapter 1, "Introduction" describes the features and functions of the XW Automatic Generator Start Module.

Chapter 2, "Installation" contains information and procedures to install the XW Automatic Generator Start.

Chapter 3, "Configuration" contains information and procedures for configuring the XW Automatic Generator Start.

Chapter 4, "Operation" describes the operation of the XW Auto Generator Start and how to get the most from its features.

Chapter 5, "Troubleshooting" contains information and procedures to troubleshoot the XW Automatic Generator Start.

Appendix A, "Specifications", contains the electrical, mechanical, and environmental specifications for the XW Automatic Generator Start.

Appendix B, “Generator Auto Start Requirements and Types”, provides general information about generators that will work with the XW Automatic Generator Start.

Appendix C, “Relay Timing” contains information about relay configuration and timing for each basic type of starting mode for the XW Automatic Generator Start.

“Warranty and Return Information” contains the warranty for your XW Automatic Generator Start as well as instructions for returning the product for servicing.

Conventions Used

The following conventions are used in this guide.



WARNING

Warnings identify conditions or practices that could result in personal injury or loss of life



CAUTION

Cautions identify conditions or practices that could result in damage to the unit or other equipment.

Important: These notes contain information that is important for you to know, but is not as critical as a caution or warning.

Related Information

For more information about related components, refer to:

- XW System Overview (975-0238-01-01)
- XW Power System Installation Guide (975-0239-01-01)
- XW Inverter/Charger Operator’s Guide (975-0240-01-01)
- XW System Control Panel Owner’s Guide (975-0298-01-01)
- XW Solar Charge Controller Owner’s Guide (975-0283-01-01)

These guides are available at **www.xantrex.com**, where you can find more information about Xantrex Technology Inc. and its products and services.

Important Safety Instructions



WARNING: Save these instructions

This Owner's Guide contains important safety and operating instructions. Before using your XW Automatic Generator Start, be sure to read, understand, and save these safety instructions.



WARNING: Restrictions on use

The XW Automatic Generator Start shall not be used in connection with life support systems or other medical equipment or devices.



WARNING: Safety hazard

Disable the XW Automatic Generator Start if the generator or vehicle equipped with the generator is in an enclosed building or area where the generator exhaust is not vented to the outside.

General Precautions

1. Before installing and using the XW Automatic Generator Start, read all appropriate sections of this guide.
2. If the XW Automatic Generator Start is inoperative, see “Warranty and Product Information” on page WA-1.
3. Do not dismantle the XW Automatic Generator Start; it contains no user serviceable parts. See “Information About Your System” on page WA-5 for instructions on obtaining service.
4. Protect the XW Automatic Generator Start from rain, snow, spray, and water.
5. Disable the generator's starting circuit by disconnecting the starter battery, spark plug, et cetera, before wiring this device.
6. To reduce the risk of electrical shock, put the Xantrex Xanbus system into Standby before working on any circuits connected to it. See “Putting the XW Auto Generator Start in Standby Mode” on page 4-6.

7. Disable the automatic starting circuit and/or disconnect the generator from its starting battery to prevent accidental starting while performing maintenance.

Explosive Gas Precautions



WARNING: Explosion hazard

This equipment is not ignition protected. To prevent fire or explosion, do not install the XW Automatic Generator Start in locations that require ignition-protected equipment. This includes any space containing gasoline-powered machinery, fuel tanks, as well as joints, fittings, or other connections between components of the fuel system.

Be sure you follow all relevant instructions exactly before installing or using your XW Automatic Generator Start.

FCC Information to the User

This equipment has been tested and found to comply with the limits for a Class B digital device, pursuant to part 15 of the FCC Rules. These limits are designed to provide reasonable protection against harmful interference when the equipment is operated in a residential environment. This equipment generates, uses and can radiate radio frequency energy and, if not installed and used in accordance with the instruction guide, may cause harmful interference to radio communications. However, there is no guarantee that interference will not occur in a particular installation. If this equipment does cause harmful interference to radio or television reception, which can be determined by turning the equipment off and on, the user is encouraged to try to correct the interference by one or more of the following measures:

- Reorient or relocate the receiving antenna.
- Increase the separation between the equipment and the receiver.
- Connect the equipment into a circuit different from that to which the receiver is connected.
- Consult the dealer or an experienced radio/TV technician for help.

Contents

Important Safety Instructions	v
--	---

1 Introduction

Purpose	1-2
System Requirements	1-3
Functions	1-4
Features	1-5
Front Panel	1-5
Bottom Panel	1-6

2 Installation

Preparing an Installation	2-2
Tools and Materials Required	2-2
Choosing a Location	2-2
Routing the Connections	2-3
Installing the XW Automatic Generator Start	2-4
Mounting the Unit	2-4
Wiring to the 20-contact Connector	2-5
Connecting the Generator	2-8
Type 1	2-9
Type 2	2-10
Type 3	2-11
Type 4	2-12
Type 5	2-13
Type 6	2-14
Type 7	2-15
Type 8	2-16
Type 9	2-17
Type 10	2-18
Type 11	2-19
Type 12	2-20
Type 13	2-21

Connecting the Thermostats (optional) ----- 2-22
Connecting an External Shutdown (optional) ----- 2-22
Connecting an External Manual ON/OFF Switch (optional) ----- 2-23
 Connecting an External ON/OFF LED ----- 2-24
Connecting the Wiring Harness to the XW Auto Generator Start ----- 2-26
Connecting the XW Auto Generator Start to the Xanbus Network ----- 2-27
Verifying Power Is Available ----- 2-28

3 Configuration

Overview ----- 3-2
Accessing the XW Auto Generator Start Menu ----- 3-3
The XW Auto Gen Start Menu ----- 3-4
 The Configuration Menu ----- 3-7
 QT En ----- 3-7
 QT Begin ----- 3-8
 QT End ----- 3-9
 Gen Type ----- 3-9
 Cfg Trigger Menu ----- 3-11
 Start DCV 30 sec ----- 3-12
 Start DCV 15 min ----- 3-13
 Start DCV 2 hr ----- 3-14
 Start DCV 24 hr ----- 3-15
 Stop Float ----- 3-16
 Stop Absorb ----- 3-16
 Stop V ----- 3-17
 Temp1 ----- 3-18
 Temp2 ----- 3-18
 Load ----- 3-18
 Start Load ----- 3-19
 Stop Load ----- 3-20
 Cfg Gen Menu ----- 3-20
 Starter Cool Down ----- 3-21
 Gen Cool Down ----- 3-21
 Max Run Time ----- 3-22
 Exercise Per ----- 3-22
 Exercise Dur ----- 3-23
 Exercise Time ----- 3-24
 Relay3 ----- 3-24

Gen Run Hold Time	3-25
Crank Delay	3-25
Crank Time	3-25
Crank Retry Time	3-26
Preheat Time	3-26
Gen Start Tries	3-26
Multi-unit Config	3-27
Dev Name	3-27
Dev Number	3-27
Connections	3-27
Restore Defaults	3-28
GenMode	3-28
Automatic Mode	3-28
Manual On Mode	3-29
Manual Off Mode	3-30
Mode	3-30
The View Device Info Menu	3-30
View Fault Log	3-30
View Warning Log	3-30
View Event Log	3-31
User Settings	3-32

4 Operation

Accessing the XW Auto Generator Start Home Screen	4-2
Starting and Stopping the Generator	4-3
Using Quiet Time	4-4
Modes of Operation	4-5
Putting the XW Auto Generator Start in Standby Mode	4-6
Returning the XW Auto Generator Start to Operating Mode	4-7

5 Troubleshooting

Faults and Warnings	5-2
Warning Messages	5-3
Fault Messages	5-6

A Specifications

Electrical Specifications	A-2
Mechanical Specifications	A-3
Environmental Specifications	A-4
Regulatory Compliance	A-4

B Generator Auto Start Requirements and Types

Recommended Features	B-2
Generator Starting Types	B-2
Two Wire	B-3
Identification	B-3
Connection	B-3
Three-Wire Onan	B-3
Identification	B-3
Connection	B-4
Three-Wire Automotive	B-4
Identification	B-4
Connection	B-4

C Relay Timing

RunMode	C-2
MomentaryRun Mode	C-3
GlowStop Mode	C-4
StartStop Mode	C-4
PulseStop Mode	C-5

Figures

Figure 1-1	XW Automatic Generator Start Basic Function - - - - -	1-2
Figure 1-2	XW Auto Generator Start Front Panel - - - - -	1-5
Figure 1-3	XW Auto Generator Start Bottom Panel - - - - -	1-6
Figure 1-4	Wiring Harness - - - - -	1-6
Figure 2-1	XW Auto Generator Start External Connections- - - - -	2-3
Figure 2-2	XW Auto Generator Start Wiring Harness- - - - -	2-6
Figure 2-3	Type 1 Connection Diagram - - - - -	2-9
Figure 2-4	Type 2 Connection Diagram - - - - -	2-10
Figure 2-5	Type 3 Connection Diagram - - - - -	2-11
Figure 2-6	Type 4 Connection Diagram - - - - -	2-12
Figure 2-7	Type 5 Connection Diagram - - - - -	2-13
Figure 2-8	Type 6 Connection Diagram - - - - -	2-14
Figure 2-9	Type 7 Connection Diagram (two-wire) - - - - -	2-15
Figure 2-10	Type 7 Connection Diagram (three-wire) - - - - -	2-15
Figure 2-11	Type 8 Connection Diagram (two-wire) - - - - -	2-16
Figure 2-12	Type 8 Connection Diagram (three-wire) - - - - -	2-16
Figure 2-13	Type 9 Connection Diagram - - - - -	2-17
Figure 2-14	Type 10 Connection Diagram - - - - -	2-18
Figure 2-15	Type 11 Connection Diagram - - - - -	2-19
Figure 2-16	Type 12 Connection Diagram - - - - -	2-20
Figure 2-17	Type 13 Connection Diagram - - - - -	2-21
Figure 2-18	External ON/OFF Switch and LED Wiring Diagram- - - - -	2-25
Figure 2-19	XW Auto Generator Start External Connections- - - - -	2-26
Figure 2-20	Connecting the XW System Control Panel - - - - -	2-27
Figure 2-21	Verifying Power is Available - - - - -	2-28
Figure 3-1	XW System Control Panel Navigation Buttons and XW System Home Screen	3-2
Figure 3-2	Accessing the XW Automatic Generator Start Menu- - - - -	3-3
Figure 3-3	Changing Settings - - - - -	3-4
Figure 3-4	XW Auto Generator Start Basic Menu Contents- - - - -	3-5
Figure 3-5	XW Auto Generator Start Configuration Menu Contents - - - - -	3-6
Figure 4-1	XW Auto Generator Start Home Screen - - - - -	4-2

Figures

Figure 4-2	Starting and Stopping the Generator-----	4-3
Figure 4-3	Using the Quiet Time Feature-----	4-4
Figure 4-4	Changing the Mode to Standby-----	4-6
Figure 4-5	Returning the Mode to Operating-----	4-7
Figure A-1	XW Auto Generator Start Dimensions-----	A-3
Figure C-1	RunMode Timing Diagram-----	C-2
Figure C-2	MomentaryRun Mode Timing Diagram-----	C-3
Figure C-3	GlowStop Mode Timing Diagram-----	C-4
Figure C-4	StartStop Mode Timing Diagram-----	C-5
Figure C-5	PulseStop Mode Timing Diagram-----	C-6
Figure C-6	PulseStop Mode Relay 1 Behavior-----	C-6

Tables

Table 1-1	Front panel features - - - - -	1-5
Table 2-1	Circuit Limitations - - - - -	2-5
Table 2-2	Required Wiring Size Based on Length of Cable - - - - -	2-6
Table 2-3	Contact Numbers and Functions - - - - -	2-7
Table 2-4	Type 1 Relay and Timing Preset Configurations- - - - -	2-9
Table 2-5	Type 2 Relay and Timing Preset Configurations- - - - -	2-10
Table 2-6	Type 3 Relay and Timing Preset Configurations- - - - -	2-11
Table 2-7	Type 4 Relay and Timing Preset Configurations- - - - -	2-12
Table 2-8	Type 5 Relay and Timing Preset Configurations- - - - -	2-13
Table 2-9	Type 6 Relay and Timing Preset Configurations- - - - -	2-14
Table 2-10	Type 7 Relay and Timing Preset Configurations- - - - -	2-15
Table 2-11	Type 8 Relay and Timing Preset Configurations- - - - -	2-16
Table 2-12	Type 9 Relay and Timing Preset Configurations- - - - -	2-17
Table 2-13	Type 10 Relay and Timing Preset Configurations- - - - -	2-18
Table 2-14	Type 11 Relay and Timing Preset Configurations- - - - -	2-19
Table 2-15	Type 12 Relay and Timing Preset Configurations - - - - -	2-20
Table 2-16	Type 13 Relay and Timing Preset Configurations- - - - -	2-21
Table 2-17	Wiring for Connecting Thermostats - - - - -	2-22
Table 2-18	Wiring for Connecting an External Shutdown - - - - -	2-22
Table 2-19	Wiring for Connecting an External Manual ON/OFF Switch - - - - -	2-24
Table 3-1	Generator Type Descriptions and Examples- - - - -	3-9
Table 3-2	Trigger Event Descriptions - - - - -	3-31
Table 3-3	Generator Configuration Settings, Values, Defaults, and User Settings --	3-32
Table 5-1	XW Auto Generator Start Warning Messages - - - - -	5-3
Table 5-2	XW Auto Generator Start Fault Messages - - - - -	5-6

1

Introduction

Chapter 1, “Introduction” describes the features and functions of the XW Automatic Generator Start Module.

For this Topic....	See....
“Purpose”	page 1–2
“System Requirements”	page 1–3
“Functions”	page 1–4
“Features”	page 1–5

Purpose

Important: The XW Automatic Generator Start (XW Auto Generator Start) is designed for use in an XW Power System only.

ADDITIONAL EQUIPMENT REQUIRED. The XW Auto Generator Start requires the use of a XW System Control Panel for configuration and monitoring. For details see “System Requirements”. Use the XW Power System Installation Guide to integrate this component into the overall system.

Function

The Xantrex™ XW Auto Generator Start continuously monitors battery voltage and starts, or stops, the generator when battery voltage drops below or exceeds the preset limits. It also starts the generator to assist the system’s inverter/charger when output power demands are high.

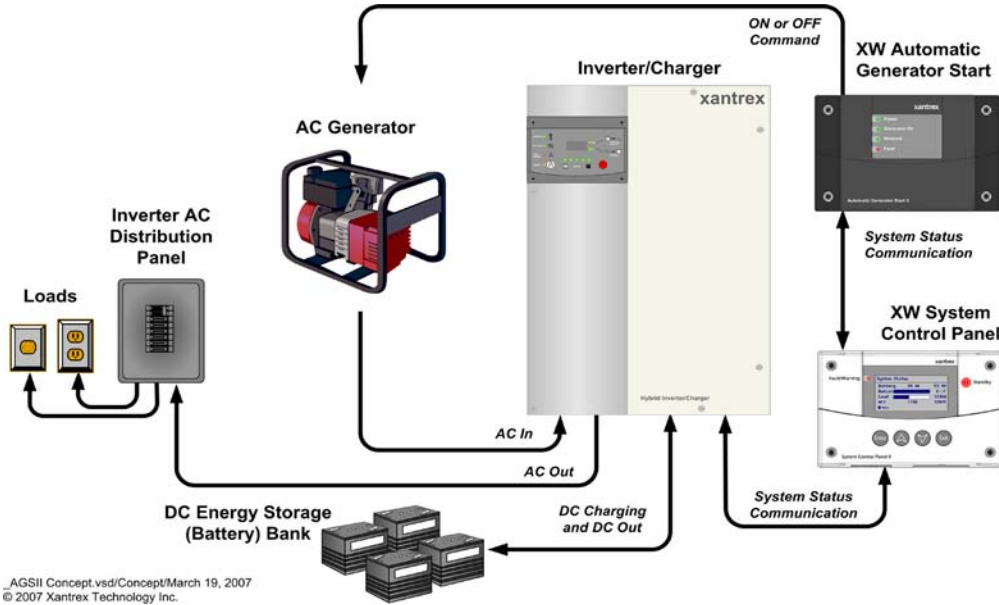

Figure 1-1 XW Automatic Generator Start Basic Function

Start and Stop Triggers

The XW Auto Generator Start requires a source of start and stop triggers for automatic operation. The XW Auto Generator Start monitors the Xanbus network and starts or stops the generator based on the preset limits programmed into it.

Specific criteria that will trigger the XW Auto Generator Start are described in “Functions” on page 1–4.

System Requirements

Minimum basic system components include the following.

- An XW Inverter/Charger
- An AC Generator or DC Generator
- An XW System Control Panel
- An XW Automatic Generator Start

Network Communication Protocol

The XW Auto Generator Start uses Xanbus™, a network communications protocol developed by Xantrex, to communicate its settings and activity to other Xanbus-enabled devices. All network components used in the system must be Xanbus-enabled.

Network Power Supply

The XW Auto Generator Start requires 3 watts of power (maximum) to operate. This power supply is provided by the XW Inverter/Charger through the Xanbus network.

Generator

The generator should be a 2-wire or 3-wire generator with Auto Start capability.

The generator should also supply a Generator Run signal. This signal is used by the XW Auto Generator Start to detect whether the generator is running. Some generator manufacturers refer to this signal as the Hour Meter Signal or Switched B+.

Generator Compatibility

The XW Auto Generator Start supports most two and three-wire generator starters. Some manufacturers include, but are not limited to, Onan (Quiet Diesel, gasoline, and LP), Power Tech, Generac, Northern Lights, Fisher Panda, Westerbeke, Kohler, Honda, and Yamaha. Check with the generator manufacturer to ensure the generator in question includes automatic starting capabilities.

XW System Control Panel

A XW System Control Panel is required to configure the XW Auto Generator Start and monitor generator starting and stopping activity.

The XW System Control Panel also provides real-time clock information for the XW Auto Generator Start Quiet Time and Exercise Time features.

Functions

Generator Starting Triggers

The XW Auto Generator Start can automatically start a generator in response to:

- low battery voltage
- high battery drain from the AC loads
- a thermostat signal
- a pre-programmed exercise period at a specified time of day.

Generator Stopping Triggers

The XW Auto Generator Start can automatically stop a generator in response to:

- the introduction of qualified grid power (grid power within acceptable parameters)
- high battery voltage
- battery charge stage (float or absorb stage)
- removal of a high battery drain from the AC loads
- a thermostat signal
- a pre-programmed quiet time period

The XW Auto Generator Start can also be used to manually start and stop the generator at any time.

Programmable Features

Quiet Time The XW Auto Generator Start features a quiet time setting, which prevents the generator starting at night or during other inconvenient periods.

Exercise Period During times of prolonged generator inactivity, the XW Auto Generator Start can be programmed to run (or “exercise”) the generator for a pre-defined period. This ensures the generator remains operational and that the starting battery stays charged.

Status Reporting

The XW Auto Generator Start reports its operating mode, its settings, generator activity, and the reason for generator starts to the Xanbus system. This information can be viewed on the XW System Control Panel.

Installation Options

The XW Auto Generator Start can be installed with an external shutdown input, a manual generator ON/OFF switch, and an external ON/OFF indicator light.

Features

- Indicator Lights** Four lights on the front panel indicate the operating status and network status of the XW Auto Generator Start.
- Connectors** Two network ports on the bottom panel connect the XW Auto Generator Start to the Xanbus system. A 20-contact pluggable connector (also on the bottom panel) allows the XW Auto Generator Start to connect to the generator’s starting circuitry, thermostats and external switches. See “*Bottom Panel*” on page 1–6.

Front Panel

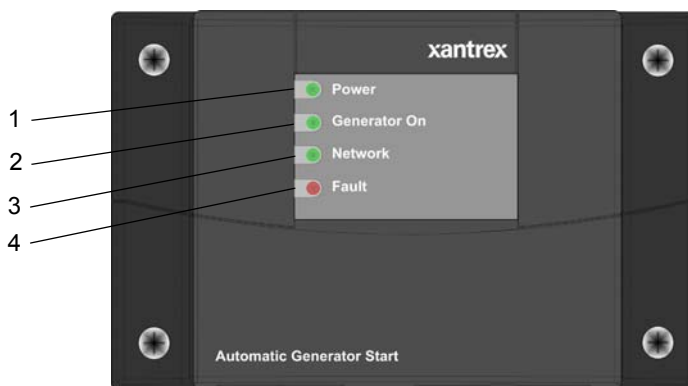

Figure 1-2 XW Auto Generator Start Front Panel

Table 1-1 Front panel features

Feature	Description
1	Power light (green) indicates the XW Auto Generator Start is receiving network power.
2	Generator On light (green) indicates the generator is running. This light turns on when the generator run signal is active. See “ <i>Important</i> ” on page 2–24.
3	Network light (green) indicates the XW Auto Generator Start is communicating with other Xanbus-enabled devices.
4	Fault light (red) indicates an XW Auto Generator Start fault has occurred. See “ <i>Troubleshooting</i> ” on page 5–1 for information about XW Auto Generator Start faults.

Bottom Panel

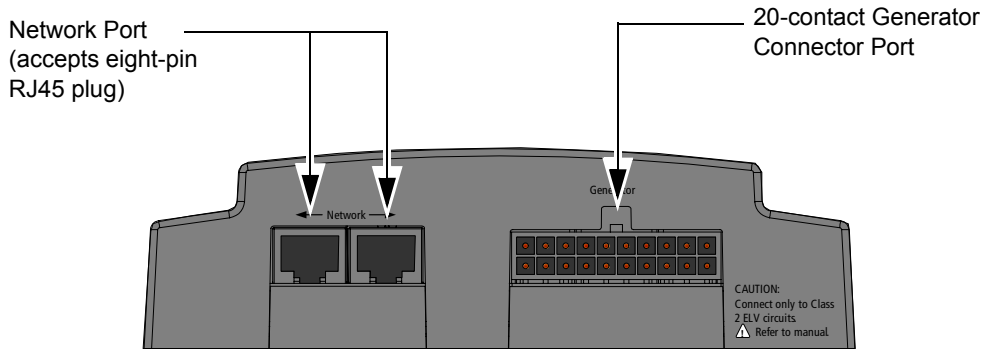

Figure 1-3 XW Auto Generator Start Bottom Panel

Network Port Each network port can accept an eight-pin RJ45 plug attached to a Category 5 (CAT 5) network cable. Depending on the installation, both ports may be required.



CAUTION: Equipment Damage

Connect the XW Auto Generator Start only to other Xanbus compatible devices.

Although the cabling and connectors used in this network system are the same as those used for Ethernet, **this network is not an Ethernet system**. Equipment damage may result from attempting to connect these two different systems.

20-contact Connector The 20-contact connector supports a wiring harness (included) that connects the XW Auto Generator Start to a generator and thermostats. The wiring harness also provides lines for connecting external generator shutdown sensors or switches and external generator ON/OFF controls.

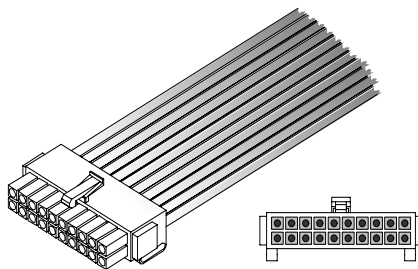

Figure 1-4 Wiring Harness

2

Installation

Chapter 2, “Installation” contains information and procedures to install the XW Automatic Generator Start.

For this Topic...	See....
“Tools and Materials Required”	page 2–2
“Choosing a Location”	page 2–2
“Routing the Connections”	page 2–3
“Mounting the Unit”	page 2–4
“Wiring to the 20-contact Connector”	page 2–5
“Connecting the Generator”	page 2–8
“Connecting the Thermostats (optional)”	page 2–22
“Connecting an External Shutdown (optional)”	page 2–22
“Connecting the Wiring Harness to the XW Auto Generator Start”	page 2–26
“Connecting the XW Auto Generator Start to the Xanbus Network”	page 2–27
“Verifying Power Is Available”	page 2–28

Preparing an Installation

Before installing the XW Auto Generator Start, consider how and where the unit will be mounted. Pre-plan the connection routes between the XW Auto Generator Start, the generator, thermostats, and the XW System Control Panel. Refer to the XW Power System Installation Guide for additional information.

Tools and Materials Required

The following tools and materials may be needed to install the XW Auto Generator Start:

- Mounting template (supplied)
- Wiring harness (Xantrex part number 809-0917, supplied)
- Four #6 screws, 1¼ inch (supplied)
- #16 or #18 AWG wire (see “Wire Size and Length” on page 2–6)
- Xantrex network cables or equivalent (Category 5)
- Network terminators (if required) (supplied)
- Phillips screwdriver
- Wire cutters and wire strippers

Choosing a Location

The XW Auto Generator Start should be installed in a location that meets the following requirements:

- | | |
|---------------------------|---|
| Dry | The unit is intended for use in a dry location. The XW Auto Generator Start complies with UL458 Marine Supplement drip-test requirements, but the location should be as dry as possible. |
| Cool | The XW Auto Generator Start operation is guaranteed between -4 and 122 °F (-20 and 50 °C). |
| Safe | The XW Auto Generator Start is not ignition protected. Do not install it in areas requiring ignition-protected equipment, such as compartments housing gasoline engines. |
| Close to generator | Avoid excessive wire lengths and use the recommended wire lengths and sizes (see “Wire Size and Length” on page 2–6). It is more important for the XW Auto Generator Start to be close to the generator than close to the inverter, although for safety reasons, the XW Auto Generator Start should not be installed in the same compartment as a gasoline-powered generator. |

Routing the Connections



WARNING: Explosion Hazard

This equipment is not ignition protected. To prevent fire or explosion, do not install the XW Auto Generator Start in locations that require ignition-protected equipment. This includes any space containing gasoline-powered machinery, fuel tanks, as well as joints, fittings, or other connections between components of a fuel system.

Follow all relevant instructions exactly before installing or using your XW Auto Generator Start.



WARNING: Shock and Energy Hazards

Before making any connections to the generator, ensure that the generator's starter is disabled and the generator's start battery is disconnected.

Connection Types

Because the XW Auto Generator Start will be part of a Xanbus system, it is necessary to consider how to route two types of connections:

- connections to the generator, thermostats, and other external devices and switches, using the included 20-contact connector and wiring harness.
- connections to other Xanbus-enabled devices, using network cables.

For information on designing and installing the network, see the XW Power System Installation Guide.

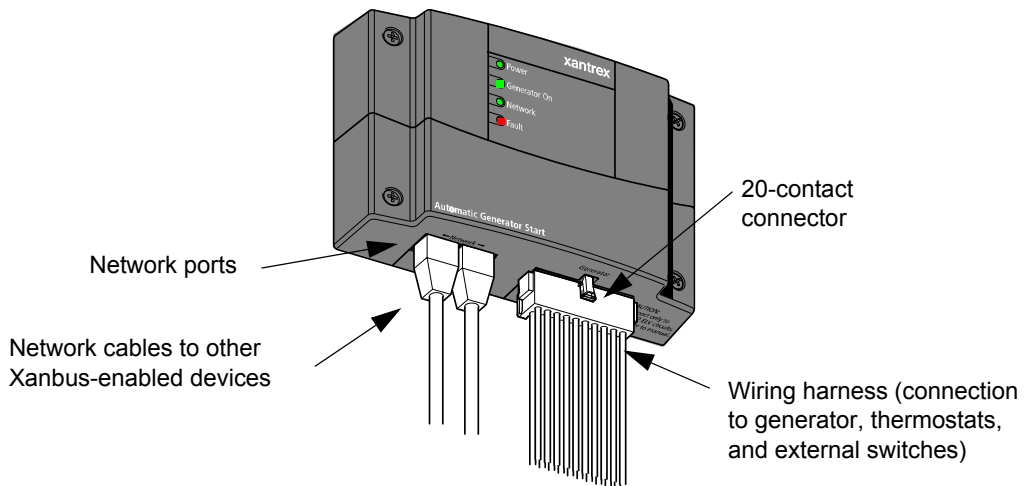

Figure 2-1 XW Auto Generator Start External Connections

Installing the XW Automatic Generator Start

Installation Overview

Installing the XW Auto Generator Start involves the following steps:

1. Mounting the unit.
2. Connecting the wiring harness to:
 - the generator (page 2–8)
 - thermostats (optional) (page 2–22)
 - external shutdown switch (optional) (page 2–22)
 - external ON/OFF switch and LED (optional) (page 2–23)
3. Connecting the wiring harness to the 20-contact connector on the XW Auto Generator Start.
4. Connecting the XW Auto Generator Start to the XW System Control Panel and other network-enabled devices (page 2–26).

Important: Because each installation varies according to the location, the type of generator, and the overall complexity of the Xanbus system, these instructions can offer only general guidelines for the many installation options available.



WARNING: Shock Hazard

Before installing the XW Auto Generator Start as part of a pre-existing Xanbus system, put the system in Standby in order to disable the electrical operation of networked devices. See “Putting the XW Auto Generator Start in Standby Mode” on page 4–6.

Mounting the Unit

The XW Auto Generator Start is to be mounted vertically on a wall with the connectors facing downwards.

To mount the XW Auto Generator Start:

1. Hold the unit flush and square against the wall, panel, or horizontal surface.
 - If the mounting surface requires pre-drill holes for the screws, use the supplied mounting template to mark, then drill, four holes.
2. With a Phillips screwdriver and the supplied #6 screws, secure each corner of the XW Auto Generator Start to the mounting surface.

Wiring to the 20-contact Connector



CAUTION: Shock Hazard

All installation wiring should be performed by a qualified installer or electrician.



WARNING: Fire, Shock, and Energy Hazards

The 20-contact connector is intended for connection to Class 2 ELV (Extra Low Voltage) circuits only. Do not exceed the circuit limitations specified in the following section.

ELV Circuits	ELV (Extra-Low Voltage) circuits have an open-circuit voltage of not more than 30 V _{rms} or 42.2 VDC or peak, and are therefore not a shock hazard.
Class 2 Circuits	As per the US National Electrical Code (NEC) and the Canadian Electrical Code (CEC), available power in Class 2 circuits is limited to 100 VA, usually by current limiting by means of overcurrent protection or series resistance. The current is limited to 5 A for circuits with open-circuit voltage of 20 V, and to $I=100/V_{oc}$ for circuits with open circuit voltage between 20 V and 30 V.
Circuit Limitations	The relay contacts in the XW Auto Generator Start are rated at 5 A maximum and all circuits on the 20-contact connector are rated at 30 V maximum.

Ensure that all circuits connected to the 20-contact connector comply with the following limits:

Table 2-1 Circuit Limitations

Circuit Parameter	Circuit Maximum
Open circuit voltage (Voc)	30 V maximum
Overcurrent protection (fuse size for open circuit voltage up to 20 V)	5 A maximum
Overcurrent protection (fuse size for open circuit voltage from 20 V to 30 V)	5 A to 3.33 A ($100/V_{oc}$ amps maximum)

Wiring Harness	Connections to the generator, thermostats, and external ON/OFF switches are made using a wiring harness that plugs into the 20-contact connector (see Figure 2-1).
----------------	--

The wires on the wiring harness can be extended to meet installation requirements. When extending the wire harness, ensure that the extension wires are the same color as the wires on the harness.

To install the XW Auto Generator Start using the wiring harness:

1. Connect each wire on the harness to its intended wire or contact on the generator, thermostats, or external switches. Tape, or otherwise secure, the unused wires to ensure they do not make unintended connections.
2. Plug the harness into the connector on the bottom panel of the XW Auto Generator Start.

Wire Identification

Each wire on the harness is identified by a number and a color. The wire numbers are shown in Figure 2-2 and their colors and functions are described in Table 2-3.

Wire Size and Length

Required wire sizes for the external connections to the wiring harness are:

Table 2-2 Required Wiring Size Based on Length of Cable

0–30 ft. (9 m)	Over 30 ft. (9 m)
18 AWG	16 AWG

When planning the routing for external connections, ensure that wire lengths are sufficient to plug the wiring harness into the XW Auto Generator Start once all the external connections are complete.

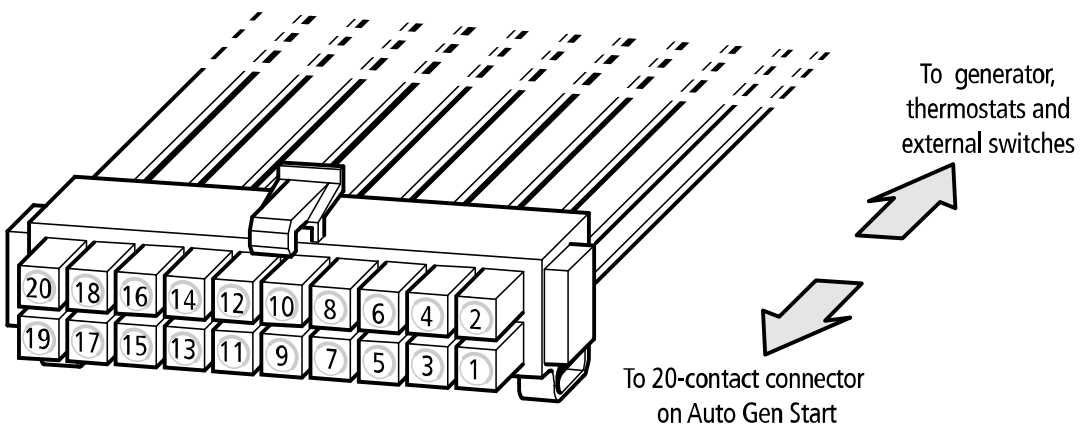

Figure 2-2 XW Auto Generator Start Wiring Harness

Table 2-3 Contact Numbers and Functions

Wire Number	Function	Wiring Harness Wire Color
1	Thermostat 1 input	Yellow
2	Thermostat 1 return	Gray
3	Thermostat 2 input	Orange
4	Thermostat 2 return	Gray
5	External shutdown input	White/Black
6	External shutdown return	Gray
7	External manual on input	White/Green
8	External manual off input	White/Red
9	External ON/OFF LED Indicator output	White/Blue
10	Constant 12/24 V B+ (battery positive) for External ON/OFF/LED Indicator	Red
11	External ON/OFF/LED Indicator return (connected internally to wire number 13)	Black
12	Generator run signal (switched B+) sense input	Violet
13	Generator run signal (switched B+) sense return (generator battery negative)	Black
14	Relay 1 (Generator run/stop) Normally open contact	Blue
15	Relay 1 (Generator run/stop) Normally closed contact	White/Violet
16	Relay 1 (Generator run/stop) Common contact	Gray
17	Relay 2 (Generator start) Normally open contact	White
18	Relay 2 (Generator start) Common contact	Gray
19	Relay 3 (Preheat/cooldown) Normally open contact	Brown
20	Relay 3 (Preheat/cooldown) Common contact	Gray

Connecting the Generator

To connect the XW Auto Generator Start to a generator, identify the start wiring configuration of the generator to be used. Generators must be auto-start capable, and generators equipped with remote operation connections are ideal.

If the generator is equipped for remote operation, examine the wiring of the remote cable and connector (or read the generator’s documentation, if available) and identify the following wires:

- Ground
- Start
- Stop
- Generator run signal, also known as the Hour Meter or Switched B+ (battery positive)

Wiring Requirements

Either #16 or #18 AWG wire is required to connect to the wiring harness. How many of these wires you connect and in which combination depends on your generator type.

Generator Types

The XW Auto Generator Start has 13 preset generator configurations, or “Gen Types” (see “Gen Type” on page 3–9). After installing the hardware, it will be necessary to select one of these Gen Types from the XW Auto Generator Start Configuration Menu on the XW System Control Panel.

Important: Put the system in Standby BEFORE changing the “Gen Type”. See “Putting the XW Auto Generator Start in Standby Mode” on page 4–6.

The following section describes the 13 preset generator configurations and provides diagrams for connecting the wiring harness to the generator’s start wiring.

Important: For an explanation of the terminology used in the following section, refer to Appendix B, “Generator Auto Start Requirements and Types”. For more information about XW Auto Generator Start internal relay activity and timing, see Appendix C, “Relay Timing”.

For instructions on changing these preset parameters, see “Cfg Trigger Menu” on page 3–11.

Type 1

Type 1 is a three-wire GlowStop configuration recommended for “three-wire” generators with glow plugs that need to be operated before a start is attempted.

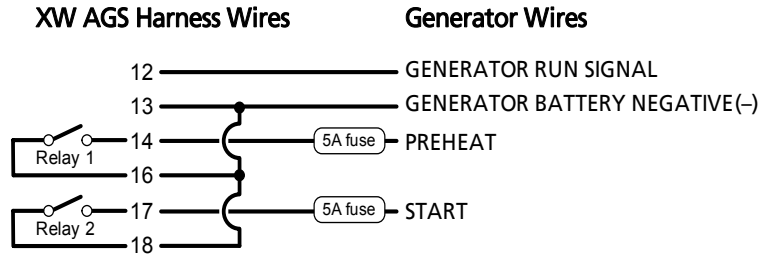

For additional information, see “Circuit Limitations” on page 2–5.

Figure 2-3 Type 1 Connection Diagram

Table 2-4 Type 1 Relay and Timing Preset Configurations

Relay Function	Preset Configuration Setting
Relay 1 mode	GlowStop
Relay 3 mode	No function
Gen Run signal hold time	0.5 s
Preheat time	20 s
Preheat to crank delay	1 s
Crank time	15 s
Crank retry time	30 s
Gen Cool Down	30 s
Shutdown bypass time	0 s
Start tries	3

Type 2

Type 2 is a three-wire GlowStop configuration recommended for “three-wire” generators that don’t require a dedicated preheat signal, such as Onan generators. In this configuration, the start signal is applied for longer because the generator does its own preheat and cranking while the start signal is applied.

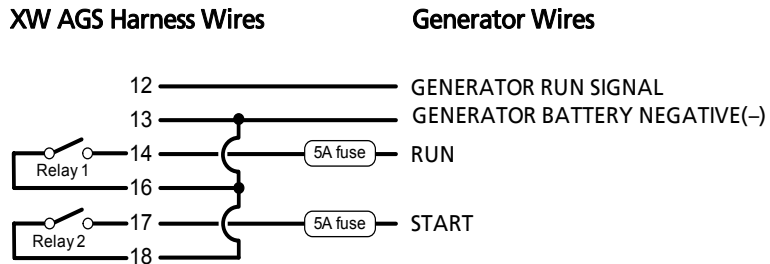

For additional information, see “Circuit Limitations” on page 2–5.

Figure 2-4 Type 2 Connection Diagram

Table 2-5 Type 2 Relay and Timing Preset Configurations

Relay Function	Preset Configuration Setting
Relay 1 mode	GlowStop
Relay 3 mode	No function
Gen Run signal hold time	0.5 s
Preheat time	0 s
Preheat to crank delay	0 s
Crank time	30 s
Crank retry time	40 s
Gen Cool Down	30 s
Shutdown bypass time	0 s
Start tries	3

Type 3

Type 3 is a three-wire GlowStop with shutdown bypass configuration. The configuration shown in Figure 2-5 uses a shutdown bypass output to temporarily disable the generator’s low oil pressure shutdown functionality during cranking. Generators with this functionality often have a manual means of disabling it during cranking.

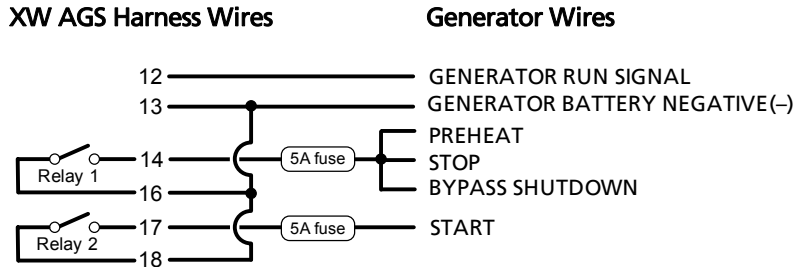

For additional information, see “Circuit Limitations” on page 2–5.

Figure 2-5 Type 3 Connection Diagram

Table 2-6 Type 3 Relay and Timing Preset Configurations

Relay Function	Preset Configuration Setting
Relay 1 mode	GlowStop/Shutdown bypass
Relay 3 mode	Preheat/Shutdown bypass
Gen Run signal hold time	0.5 s
Preheat time	20 s
Preheat to crank delay	0 s
Crank time	15 s
Crank retry time	30 s
Gen Cool Down	30 s
Shutdown bypass time	10 s
Start tries	3

Type 4

Type 4 is a three-wire StartStop configuration that uses relay 3 to provide the preheat signal for Generac’s Guardian Gas generators.

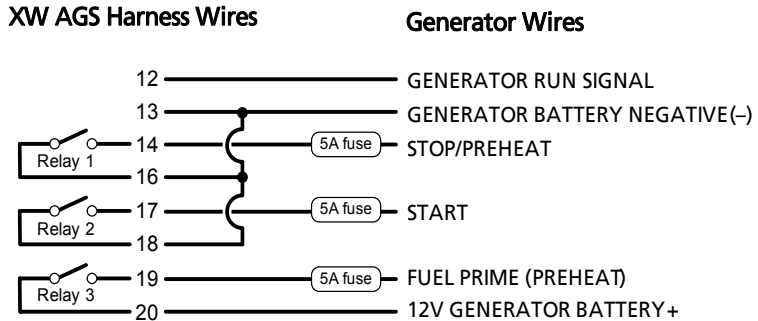

For additional information, see “Circuit Limitations” on page 2–5.

Figure 2-6 Type 4 Connection Diagram

Table 2-7 Type 4 Relay and Timing Preset Configurations

Relay Function	Preset Configuration Setting
Relay 1 mode	StartStop
Relay 3 mode	Preheat
Gen Run signal hold time	10 s
Preheat time	60 s
Preheat to crank delay	5 s
Crank time	15 s
Crank retry time	15 s
Gen Cool Down	30 s
Shutdown bypass time	0 s
Start tries	3

Type 5

Type 5 is a three-wire StartStop configuration that uses relay 3 to provide the preheat signal for Generac’s Guardian Diesel generators.

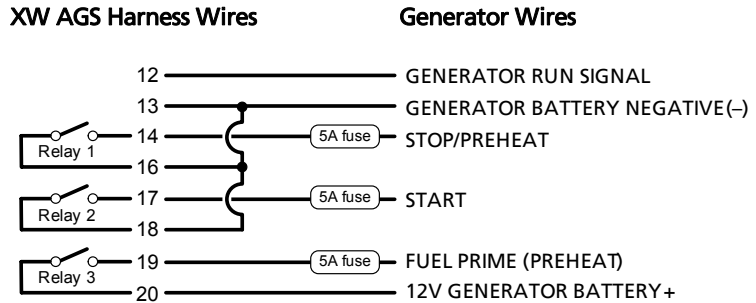

For additional information, see “Circuit Limitations” on page 2–5.

Figure 2-7 Type 5 Connection Diagram

Table 2-8 Type 5 Relay and Timing Preset Configurations

Relay Function	Preset Configuration Setting
Relay 1 mode	StartStop
Relay 3 mode	Preheat
Gen Run signal hold time	2 s
Preheat time	15 s
Preheat to crank delay	2 s
Crank time	15 s
Crank retry time	15 s
Gen Cool Down	30 s
Shutdown bypass time	0 s
Start tries	3

Type 6

Type 6 is a three-wire GlowStop configuration that has a normally closed Run/Stop contact. This generator type is intended for Yamaha generators.

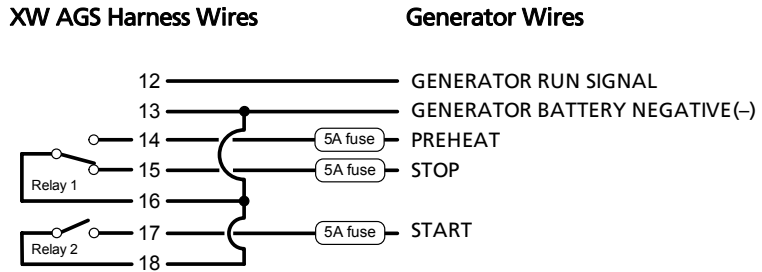

For additional information, see “Circuit Limitations” on page 2–5.

Figure 2-8 Type 6 Connection Diagram

Table 2-9 Type 6 Relay and Timing Preset Configurations

Relay Function	Preset Configuration Setting
Relay 1 mode	GlowStop
Relay 3 mode	No function
Gen Run signal hold time	0.5 s
Preheat time	10 s
Preheat to crank delay	1 s
Crank time	15 s
Crank retry time	30 s
Gen Cool Down	30 s
Shutdown bypass time	0 s
Start tries	3

Type 7

Type 7 will work with both two-wire and three-wire run mode configurations that require a preheat signal before cranking, such as Generac Backup/Renewable generators. This Gen Type setting is suitable for generators with an automatic engine cranking control system (two-wire) and generators that require that the XW Auto Generator Start control their starter separately (three-wire).

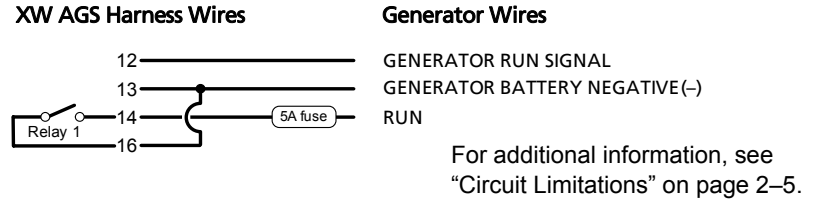

Figure 2-9 Type 7 Connection Diagram (two-wire)

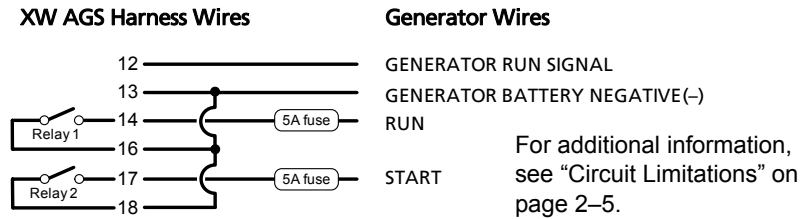

Figure 2-10 Type 7 Connection Diagram (three-wire)

Table 2-10 Type 7 Relay and Timing Preset Configurations

Relay Function	Preset Configuration Setting
Relay 1 mode	Run
Relay 3 mode	No function
Gen Run signal hold time	0.5 s
Preheat time	20 s
Preheat to crank delay	1 s
Crank time	15 s
Crank retry time	30 s
Gen Cool Down	30 s
Shutdown bypass time	0 s
Start tries	3

Type 8

Type 8 will work with both two-wire and three-wire run mode configurations and is intended for Northern Lights and Fisher Panda generators. Type 8 is identical to Type 7 except that it provides no preheat signal before cranking.

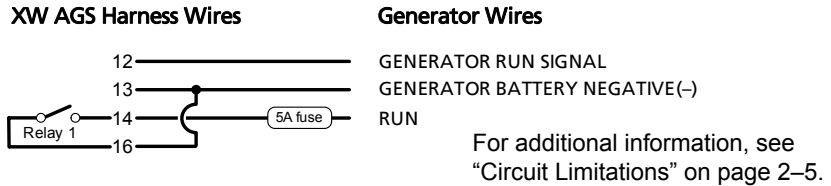

Figure 2-11 Type 8 Connection Diagram (two-wire)

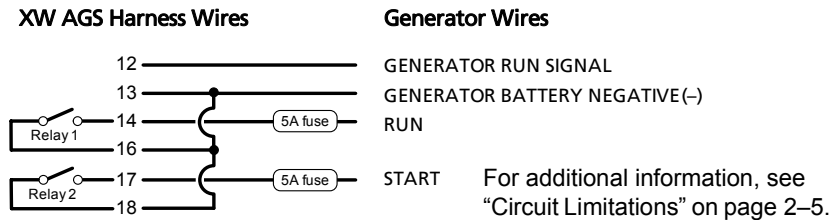

Figure 2-12 Type 8 Connection Diagram (three-wire)

Table 2-11 Type 8 Relay and Timing Preset Configurations

Relay Function	Preset Configuration Setting
Relay 1 mode	Run
Relay 3 mode	No function
Gen Run signal hold time	0.5 s
Preheat time	0 s
Preheat to crank delay	0 s
Crank time	15 s
Crank retry time	30 s
Gen Cool Down	30 s
Shutdown bypass time	0 s
Start tries	3

Type 9

Type 9 is a StartStop mode configuration with shutdown bypass functionality on relay 3. This configuration is intended for Westerbeke generators.

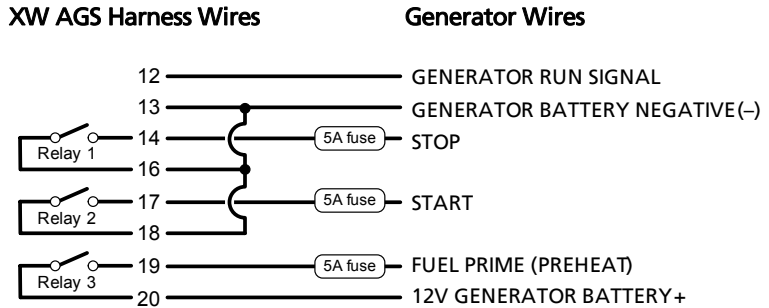

For additional information, see “Circuit Limitations” on page 2–5.

Figure 2-13 Type 9 Connection Diagram

Table 2-12 Type 9 Relay and Timing Preset Configurations

Relay Function	Preset Configuration Setting
Relay 1 mode	StartStop
Relay 3 mode	Shutdown Bypass
Gen Run signal hold time	0.5 s
Preheat time	0 s
Preheat to crank delay	0 s
Crank time	15 s
Crank retry time	30 s
Gen Cool Down	30 s
Shutdown bypass time	5 s
Start tries	3

Type 10

Type 10 is a StartStop mode configuration with no preheat signal or shutdown bypass functionality.

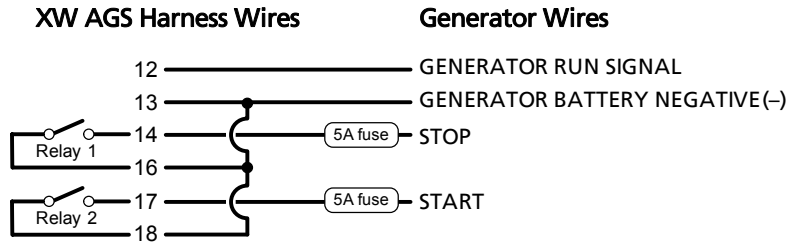

For additional information, see “Circuit Limitations” on page 2–5.

Figure 2-14 Type 10 Connection Diagram

Table 2-13 Type 10 Relay and Timing Preset Configurations

Relay Function	Preset Configuration Setting
Relay 1 mode	StartStop
Relay 3 mode	No function
Gen Run signal hold time	0.5 s
Preheat time	0 s
Preheat to crank delay	0 s
Crank time	15 s
Crank retry time	30 s
Gen Cool Down	30 s
Shutdown bypass time	0 s
Start tries	3

Type 11

Type 11 is a two-wire run mode configuration intended for Kohler generators. It requires only two wires and one relay to control the generator. Relay 1 closes momentarily once to start the generator, and closes momentarily again to stop the generator.

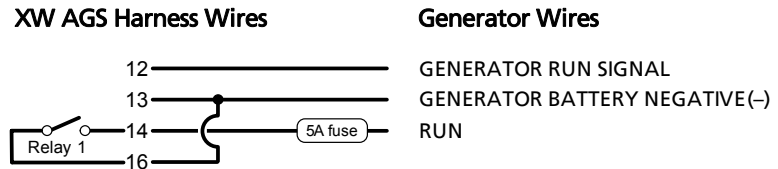

For additional information, see
“Circuit Limitations” on page 2–5.

Figure 2-15 Type 11 Connection Diagram

Table 2-14 Type 11 Relay and Timing Preset Configurations

Relay Function	Preset Configuration Setting
Relay 1 mode	MomentaryRun
Relay 3 mode	No function
Gen Run signal hold time	0.5 s
Preheat time	0 s
Preheat to crank delay	0 s
Crank time	10 s
Crank retry time	15 s
Gen Cool Down	30 s
Shutdown bypass time	0 s
Start tries	3

Type 12

Type 12 is a three-wire GlowStop configuration recommended for “three-wire” generators that don’t require a dedicated preheat signal, such as Onan propane generators. In this configuration, the start signal is applied for longer because the generator does its own preheat and cranking while the start signal is applied.

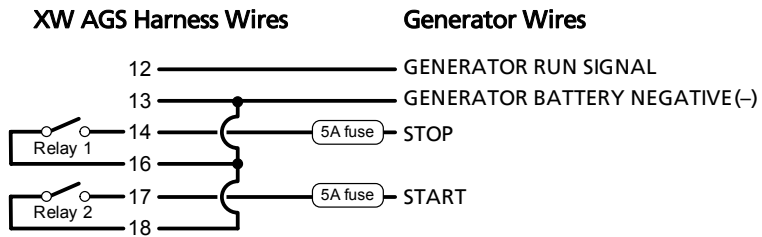

For additional information, see “Circuit Limitations” on page 2–5.

Figure 2-16 Type 12 Connection Diagram

Table 2-15 Type 12 Relay and Timing Preset Configurations

Relay Function	Preset Configuration Setting
Relay 1 mode	GlowStop
Relay 3 mode	No function
Gen Run signal hold time	4 s
Preheat time	0 s
Preheat to crank delay	0 s
Crank time	30 s
Crank retry time	40 s
Gen Cool Down	30 s
Shutdown bypass time	0 s
Start tries	3

Type 13

Type 13 is a three-wire PulseStop configuration that uses relay 3 to provide the preheat signal for PowerTech’s Diesel generators. With this generator type, there will be a delay between the generator turning off and the XW Auto Generator Start recognizing that the generator is off.

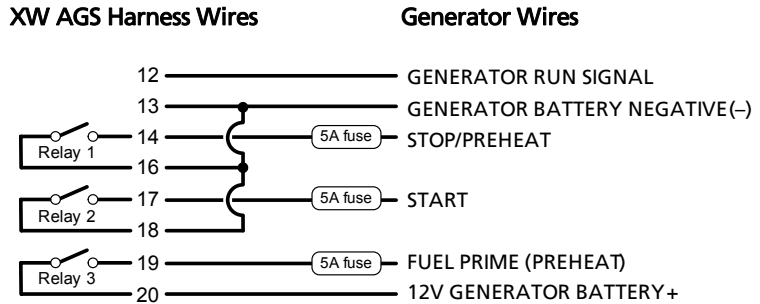

For additional information, see “Circuit Limitations” on page 2–5.

Figure 2-17 Type 13 Connection Diagram

Table 2-16 Type 13 Relay and Timing Preset Configurations

Relay Function	Preset Configuration Setting
Relay 1 mode	PulseStop
Relay 3 mode	Preheat
Gen Run signal hold time	5 s
Preheat time	15 s
Preheat to crank delay	2 s
Crank time	15 s
Crank retry time	15 s
Gen Cool Down	30 s
Shutdown bypass time	0 s
Start tries	3

Connecting the Thermostats (optional)

Wires 1, 2, 3, and 4 on the wiring harness can be connected to two thermostats. Wires 1 (yellow) and 2 (gray) are intended for thermostat 1 and wires 3 (orange) and 4 (gray) are intended for thermostat 2.

Table 2-17 Wiring for Connecting Thermostats

Wire Number	Function	Wiring Harness Wire Color
1	Thermostat 1 input (12/24 V)	Yellow
2	Thermostat 1 return (ground)	Gray
3	Thermostat 2 input (12/24 V)	Orange
4	Thermostat 2 return (ground)	Gray

These wires connect to 12-volt/24-volt output signals from the thermostats. The XW Auto Generator Start will start the generator in response to these signals. Thermostats can not be programmed using the XW Auto Generator Start.

For specific information about thermostat wiring and where XW Auto Generator Start connections should be made, please consult your thermostat documentation or contact the thermostat manufacturer.

Connecting an External Shutdown (optional)

The external shutdown input is a 12-volt/24-volt input used to assure that the XW Auto Generator Start keeps the generator off under conditions that may be potentially hazardous. Wire 5 (white/black) and 6 (gray) on the wiring harness are intended for an external switch or sensor (such as a moisture detector, or carbon monoxide detector) that produces an active high 12-volt or 24-volt output.

Table 2-18 Wiring for Connecting an External Shutdown

Wire number	Function	Wiring Harness Wire Color
5	External shutdown input (12/24 V)	White/Black
6	External shutdown return (ground)	Gray

Connecting an External Manual ON/OFF Switch (optional)

The external manual ON/OFF inputs (wires 7 and 8 on the wiring harness) are intended for wiring to one or more remote ON/OFF switches for starting and stopping the generator manually. Wire 7 (Start) and wire 8 (Stop) should each run to their own momentary-contact switch or push-button. The other contact on both switches (common) should be connected to wire 11 on the harness.

Note: Internally, wire 11 is connected to wire 13 so it should already be connected to the negative terminal on the generator battery.

In order for the XW Auto Generator Start to be able to detect these switches, connect the fused positive of the generator battery to wire 10 on the harness (the constant 12-volt/24-volt wire). See Figure 2-18 on page 2–25. Ensure all circuits added to the system comply with Table 2-1, “Circuit Limitations” on page 2–5.

If the generator battery does not have the required voltage, any 12-volt or 24-volt power source meeting the limits on page 2–5, will suit this purpose. If an alternate power source is used, its positive terminal must be connected to wire 10. Its negative must be connected to wire 11.

Note: Internally, wire 11 is connected to wire 13, so in this configuration, the alternative power source negative will be connected to the negative terminal on the generator battery.



WARNING: Fire and Shock Hazards

When making connections to a 12-volt or 24-volt power source that exceeds the class 2 power limitation of 100 VA (e.g., a battery) always use over-current protection as defined in Table 2-1. This also applies to thermostat and external manual ON/OFF connections. Locate the protection device at the power source in the positive wire.

Do not connect the XW Auto Generator Start to a 48-volt battery bank. The XW Auto Generator Start is limited to a 30V open-circuit maximum by its regulatory approval and cannot be connected to a 48-volt power source.



CAUTION: Equipment Damage

Tapping 12-volts or 24-volts from a 48-volt battery bank will unevenly wear out the batteries and shortens the battery bank life.

Table 2-19 Wiring for Connecting an External Manual ON/OFF Switch

Wire Number	Function	Wiring Harness Wire Color
7	External manual on input	White/Green
8	External manual off input	White/Red
9	External On/Off LED Indicator output	White/Blue
10	Constant 12/24 V B+ for External On/Off/LED Indicator	Red
11	External On/Off/LED Indicator return	Black

Multiple generator control panels or simple contact closures can be wired to the external manual ON/OFF inputs. The XW Auto Generator Start detects if any of the contacts close and will change its operating mode to External Manual On or External Manual Off (for more information, see “GenMode” on page 3–28). The XW Auto Generator Start turns the generator on or off according to these inputs and the resulting operating mode change.

The External Manual On and External Manual Off states are not affected by maximum generator run time (see “Max Run Time” on page 3–22).

Connecting an External ON/OFF LED

Wires 9 (White/Blue) and 11 (Black) on the wiring harness can be connected to an LED or other light to accompany a remote external ON/OFF switch. This light turns on when the generator run signal is active to visually indicate that the generator is running.

Important: With some generators, the generator run signal becomes active during the preheat stage, before the generator is actually running. In this case, the external ON/OFF LED (and the Generator On light on the XW Auto Generator Start) will turn on during the preheat stage and remain on when the generator is running.

For some generators, these lights will also remain on for a period of time after the generator has stopped.

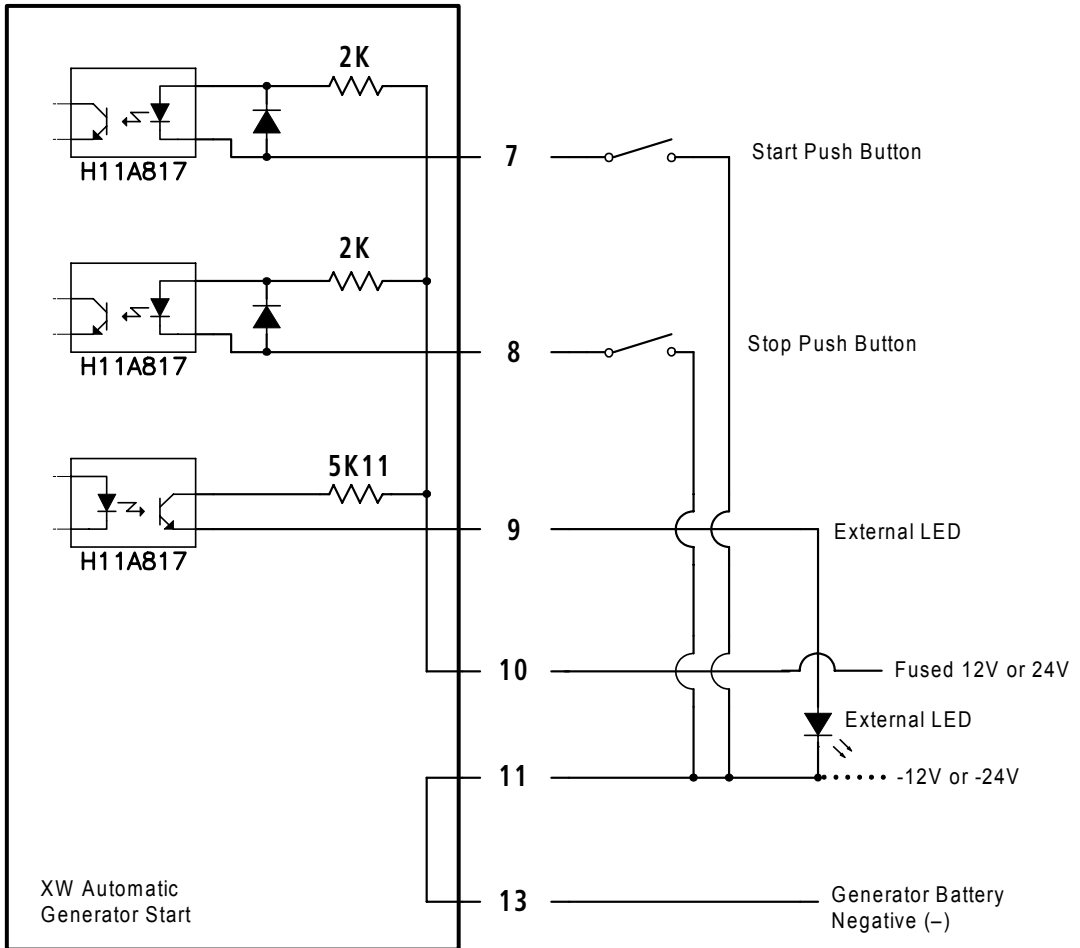

Figure 2-18 External ON/OFF Switch and LED Wiring Diagram

Connecting the Wiring Harness to the XW Auto Generator Start

After all the external connections have been wired to the wiring harness, the connector on the wiring harness must be plugged into the 20-contact connector on the XW Auto Generator Start.

To connect the wiring harness to the XW Auto Generator Start:

- ◆ With the click-tab on the wiring harness connector on top (away from the mounting surface), insert the wiring harness connector into the 20-contact connector on the XW Auto Generator Start until the tab clicks into place.

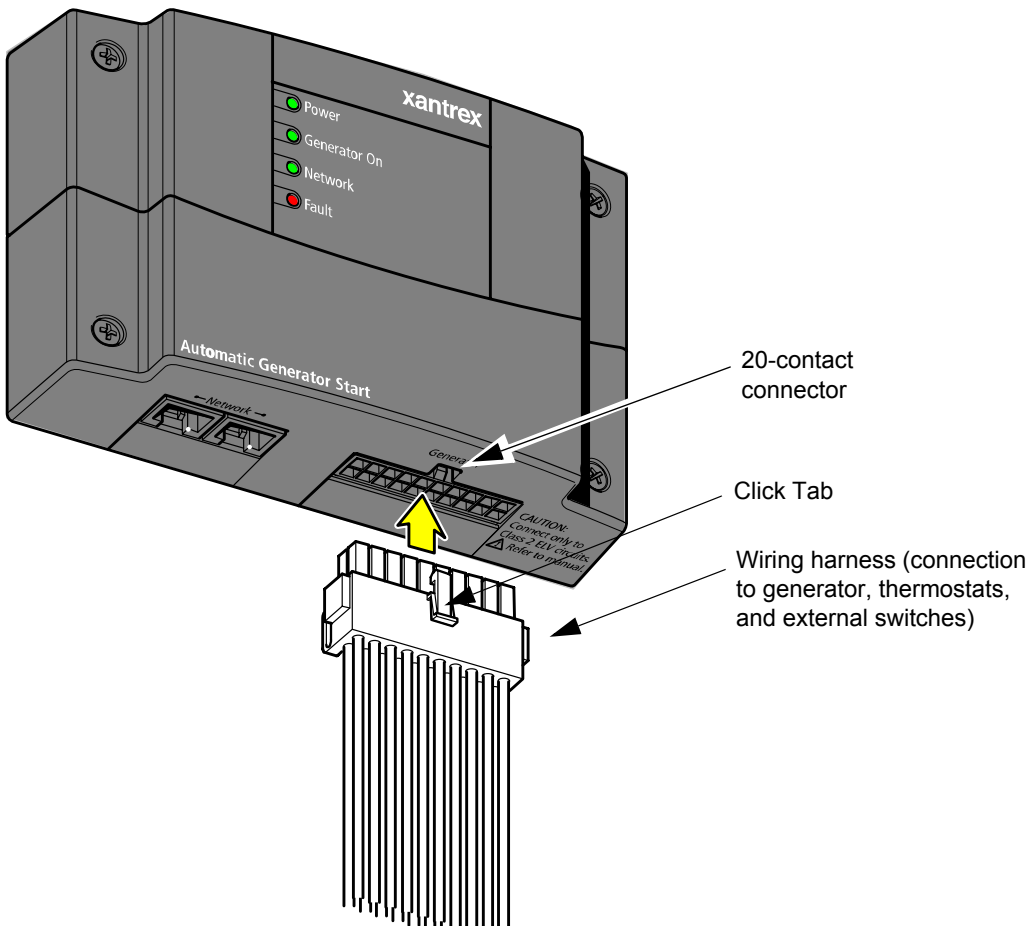

Figure 2-19 XW Auto Generator Start External Connections

Connecting the XW Auto Generator Start to the Xanbus Network



CAUTION: Equipment Damage

Connect only to other Xanbus-enabled devices.

Although the cabling and connectors used in this network system are the same as those used for Ethernet, **this network is not an Ethernet system**. Equipment damage may result from attempting to connect a Xanbus-enabled device to an Ethernet system.

To connect the XW Auto Generator Start to the Xanbus network, plug a Category 5 network cable into one of the network ports on the bottom panel of the XW Auto Generator Start. Connect the other end of that same cable to any Xanbus-enabled component that has an available network port. See Figure 2-1 on page 2–3 for the location of the ports on the XW Auto Generator Start.

If the XW Auto Generator Start is being installed on an existing Xanbus system, the system must first be put into Standby. See “Putting the XW Auto Generator Start in Standby Mode” on page 4–6.

Depending on the layout of the Xanbus system, the following options are available for the other network connector on the XW Auto Generator Start:

- A second network cable (in a “daisy-chain” network layout)
- A network terminator (in a “daisy chain” network layout where the XW Auto Generator Start is the last device at one end of the network)
- Nothing (in a multi-drop backbone layout)

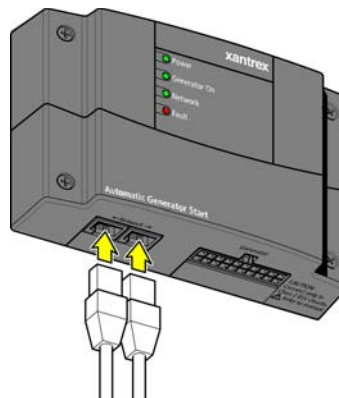

Connect 1 or 2 Category 5 network cables as required by the installation configuration.

Figure 2-20 Connecting the XW System Control Panel

Verifying Power Is Available

When the XW Auto Generator Start has been installed properly, the Power and Network indicator lights illuminate.

If one or both lights are out, check the network connections. Check the XW Inverter/Charger to ensure it has battery power. Check to make sure the other devices in the network are responding, such as the XW System Control Panel, to confirm the network is still active.

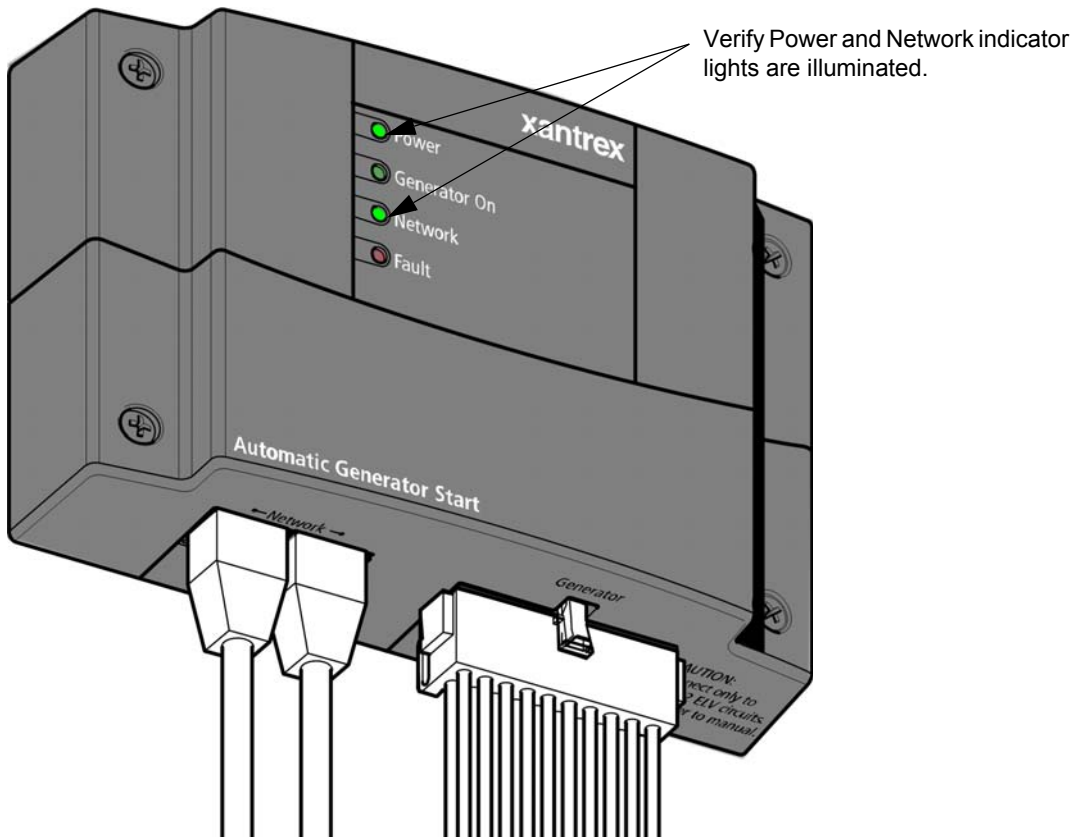

Figure 2-21 Verifying Power is Available

3

Configuration

Chapter 3, “Configuration” contains information and procedures for configuring the XW Automatic Generator Start.

For this Topic...	See....
“Overview”	page 3–2
“Accessing the XW Auto Generator Start Menu”	page 3–3
“The XW Auto Gen Start Menu”	page 3–4
“The Configuration Menu”	page 3–7
“Cfg Trigger Menu”	page 3–11
“Cfg Gen Menu”	page 3–20
“GenMode”	page 3–28
“Mode”	page 3–30
“The View Device Info Menu”	page 3–30
“User Settings”	page 3–32

Overview

The XW Auto Generator Start has a number of settings that must be configured to ensure that the generator starts and stops under the appropriate conditions and at the appropriate time. The XW Auto Generator Start is configured using the XW System Control Panel.

The XW System Home Screen on the XW System Control Panel displays basic system operational status. On the lower left corner of the XW System Home Screen, there is an arrow that points to the Enter Button below the display. Pressing the Enter Button when the XW System Home Screen is displayed will take the system to the Select Device Menu.

The XW Auto Generator Start Menu is accessed from the Select Device Menu. All configurable settings, generator mode, fault clearing, and device information is provided in the XW Auto Generator Start Menu.

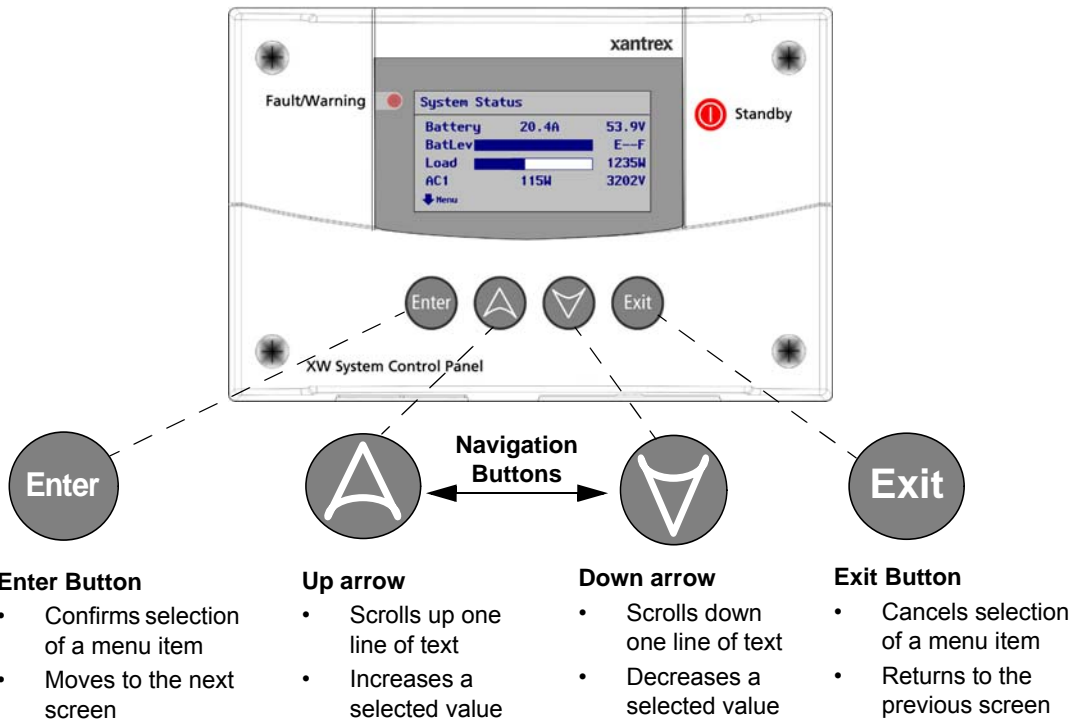

Figure 3-1 XW System Control Panel Navigation Buttons and XW System Home Screen

Accessing the XW Auto Generator Start Menu

Use the XW AGS Menu to change configuration settings, set operating mode, clear fault warnings, and view device information.

To access the XW Auto Gen Start Menu, start from the XW System Home Screen....

To view the Select Device Menu, press the Enter Button.

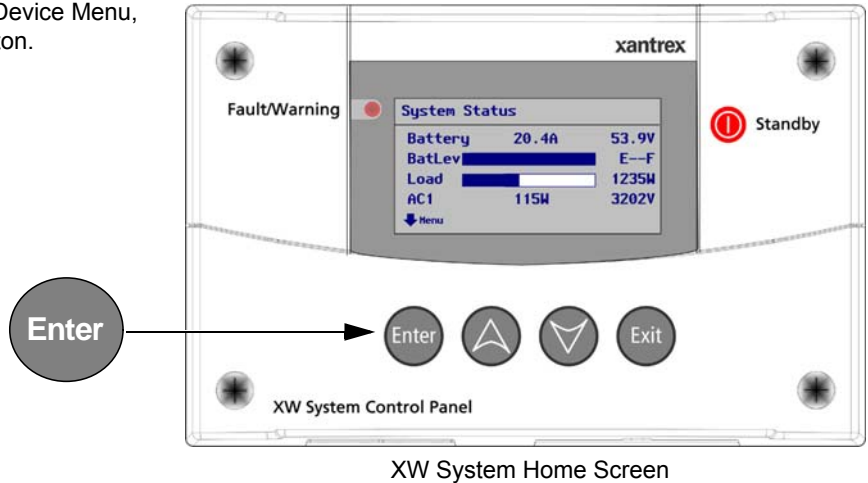

To select the XW AGS Menu, use the navigation buttons to highlight **XW AGS**.

Press the Enter Button to select the XW AGS Menu.

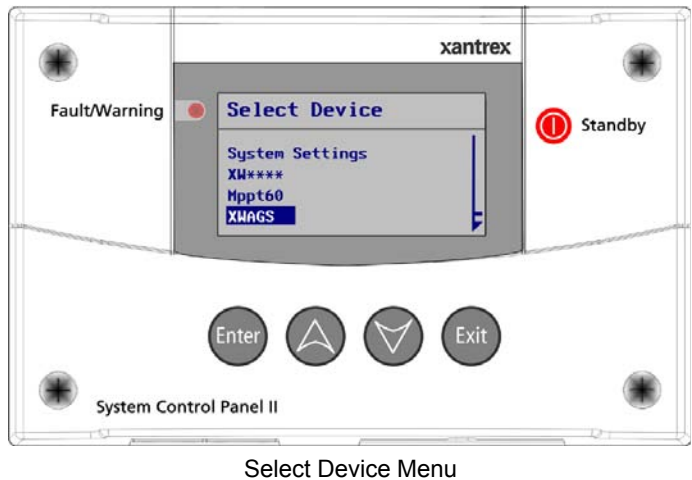
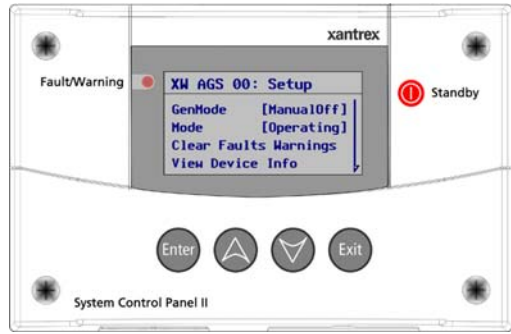

Figure 3-2 Accessing the XW Automatic Generator Start Menu

To change operational settings on the XW AGS Menu:

1. Use the Navigation Buttons to select the desired operation.
2. Press Enter to highlight the current value for that setting. Asterisks (*) indicate the last value set.
3. Use the Navigation Buttons to change the value. Holding the Navigation Button down without releasing it will scroll through the values quickly.
4. Press ENTER to select the value.
5. Press Exit twice to return to the XW System Home Screen.



Auto Gen Start Menu

See Figure 3-4.

To access the advanced settings to configure specific operational parameters:

- Press the Enter button and the Up and Down Arrow Buttons at the same time.

See Figure 3-5.

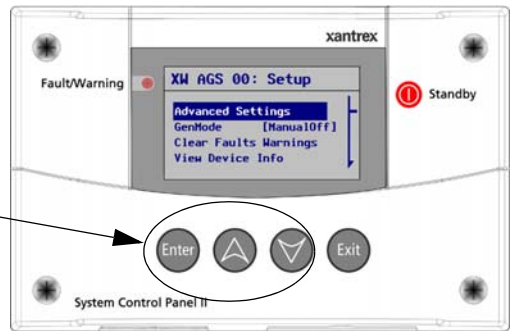

Figure 3-3 Changing Settings

The XW Auto Gen Start Menu

The XW Auto Gen Start menu provides the ability to configure the changeable parameters, select the generator’s operating mode, clear fault warnings and view device information.

The XW Auto Gen Start Menu Home Screen is divided into five sections.

- Advanced Settings (Configuration Settings)
- GenMode (Manual on/Manual off/Automatic)
- Mode of Operation (Operating/Standby)
- Clear Fault Warnings
- View Device Info

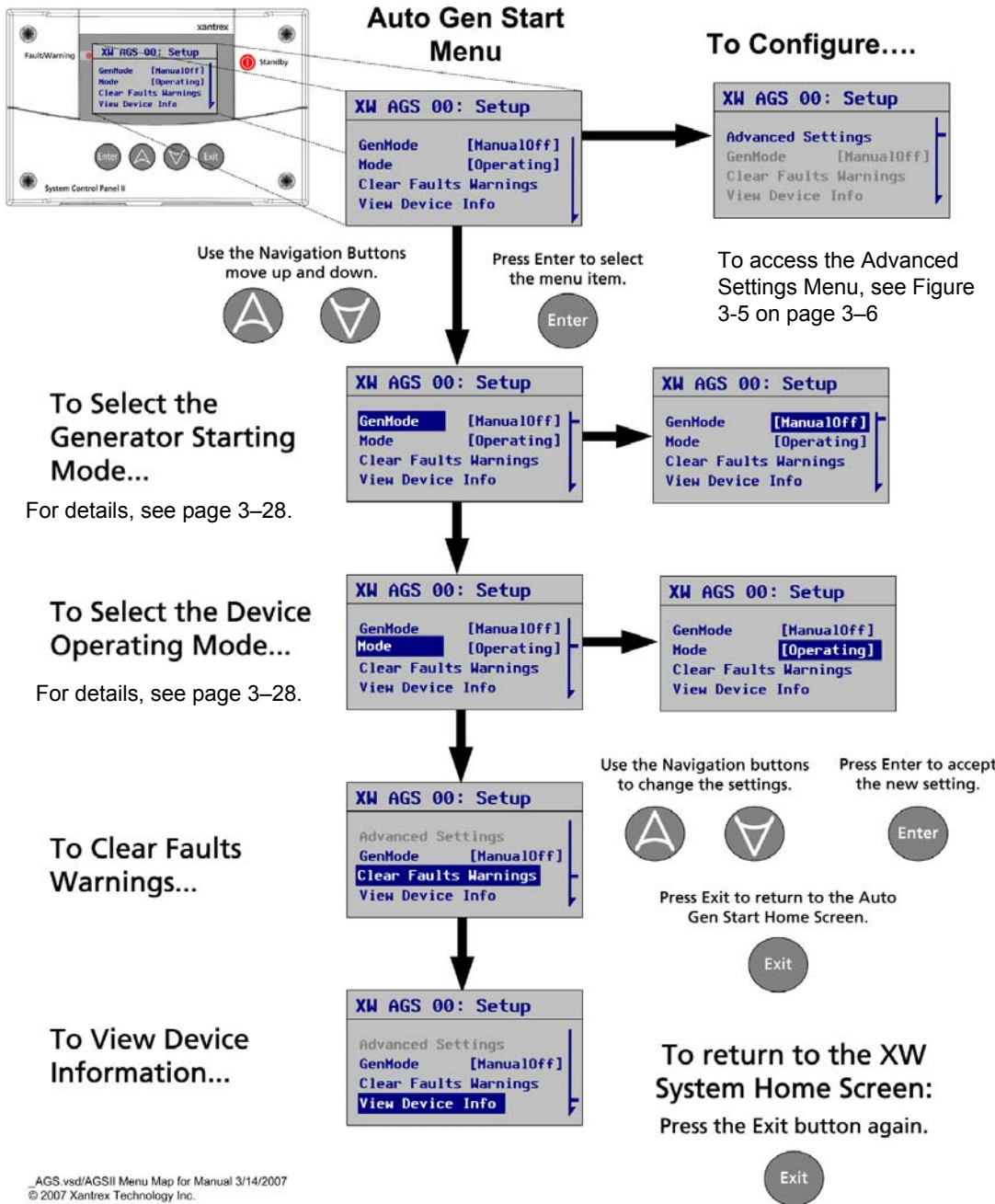

.AGS.vsd/AGSII Menu Map for Manual 3/14/2007
© 2007 Xantrex Technology Inc.

Figure 3-4 XW Auto Generator Start Basic Menu Contents

When the XW Auto Generator Start Home Screen is first displayed, the menu defaults to the GenMode Menu.

If configuration changes need to be made, the Configuration Menu can be accessed by pressing the ENTER button, the Up Arrow button, and Down Arrow button all at same time to access the Advanced Settings.

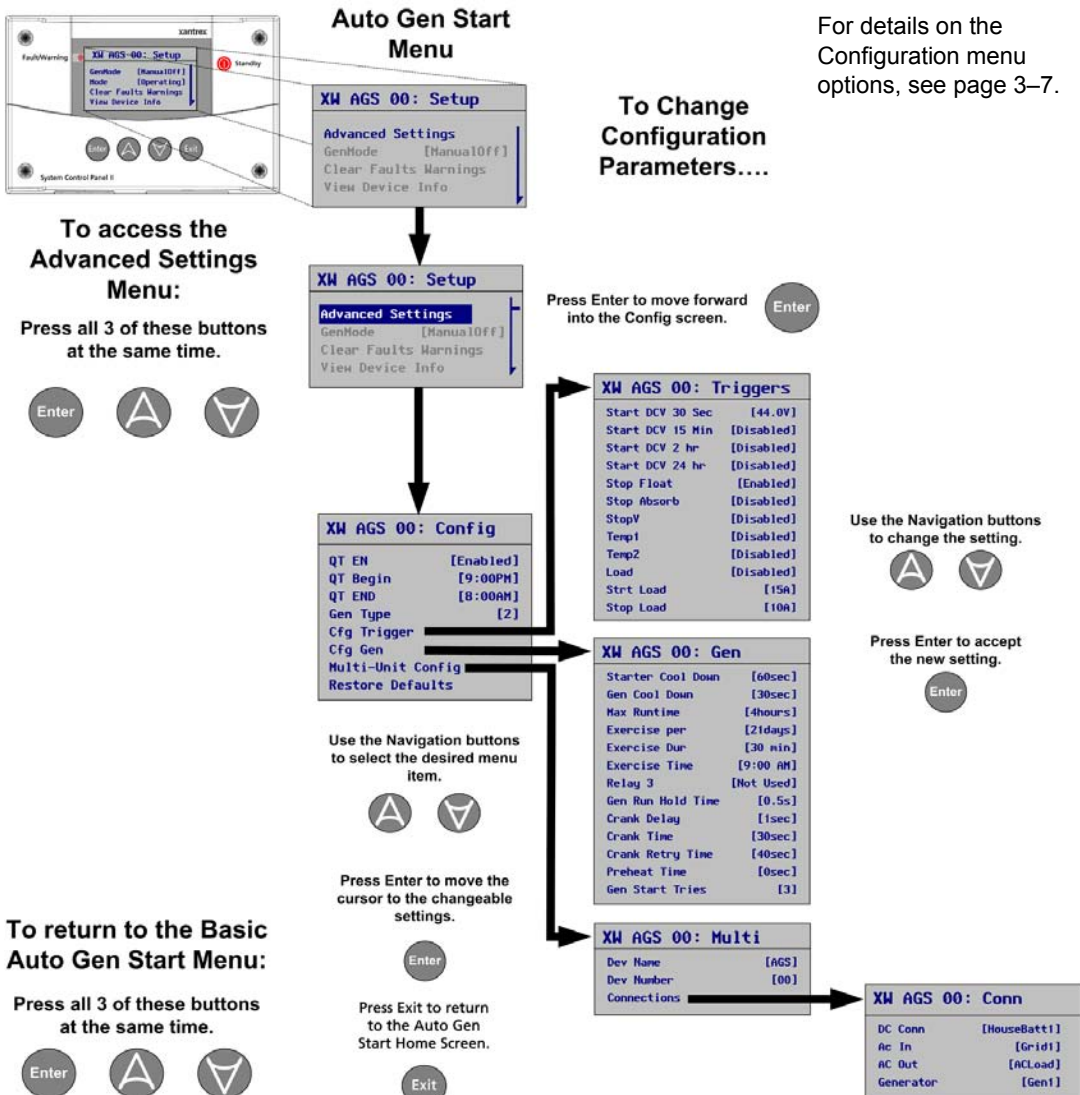

Figure 3-5 XW Auto Generator Start Configuration Menu Contents

The Configuration Menu

The Configuration Menu is where specific start-stop parameters are set. This menu contains the following settings:

- QT EN
- QT Begin
- QT END
- Gen Type
- Cfg Trigger
- Cfg Gen
- Multi-unit Config
- Restore Defaults

QT En

Full name Quiet Time Enable

Purpose “QT En” enables or disables the Quiet Time functionality of the XW Auto Generator Start. Quiet time refers to a period of time when the generator should not run.

Dependencies “QT En” requires the XW Auto Generator Start to be in Automatic mode. Setting “QT En” to [Enable] requires that parameters be set for the “QT Begin” and “QT End”.

Value	Description
Enabled/Disabled	Enables or disables the Quiet Time functionality.

When to use Set “QT En” to [Enabled] when there is a period of time when it is not desired for the generator to run. The XW Auto Generator Start will ignore all automatic start triggers during the time set in “QT Begin” and “QT Begin”.

When there are no preferences or restrictions for when the generator should run, set “QT En” to [Disabled]. When [Disabled] is selected, the XW Auto Generator Start will ignore the times set for “QT Begin” and “QT End”.

Considerations Quiet Time prevents the automatic starting of the generator regardless of battery condition.

Important: If quiet time is set for overnight, be aware that overnight battery drain can be significant as it may be necessary to use the inverter and batteries to supply AC Power without the help of a generator. Therefore, it is important to conserve battery power during this time. Minimize the use of interior lights and set thermostat temperature lower to prevent the furnace from coming on at night during cool weather. Set thermostats higher to prevent air conditioning coming on at night during warm weather.

Sometimes automatic start or automatic stop triggers may overlap with the beginning and end of quiet time. Three different quiet time scenarios affect when the generator stops and starts.

1. If quiet time begins after the XW Auto Generator Start has started the generator, the generator will stop. If the condition that started the generator is still present when quiet time ends, the generator will restart.
2. If a condition that requires starting the generator occurs during quiet time, the XW Auto Generator Start will ignore it until quiet time ends. If the condition still exists at the end of quiet time, the XW Auto Generator Start will start the generator.
3. If the running generator stops when quiet time begins and a condition that requires stopping the generator occurs during quiet time, the generator will not restart when quiet time ends.

QT Begin

Full name

Quiet Time Begin

Purpose

“QT Begin” defines the start of quiet time.

Dependencies

“QT Begin” functions only if the XW Auto Generator Start is in Automatic mode. This setting requires “QT En” be set to [Enabled] and also requires a setting for the “QT Begin” trigger. This setting is triggered by the setting on the system clock, so ensure the clock on the XW System Control Panel is set to the correct local time.

Value	Description
12:00AM to 11:59PM (12-hour clock)	At the time set for “QT Begin”, the generator will stop (if it is running) and not be able to start again until the time set for “QT End”. It ignores all automatic start triggers during the time period between “QT Begin” and “QT End”.
00:00 to 23:59 (24-hour clock)	

QT End

- Full name** Quiet Time End
- Purpose** “QT End” is a changeable setting that defines the end of quiet time. This setting also requires a setting for “QT Begin”.
- Dependencies** “QT End” functions only if the XW Auto Generator Start is in Automatic mode. This setting requires “QT En” be set to [Enabled] and also requires a setting for the “QT Begin” trigger. This setting is triggered by the setting on the system clock, so ensure the clock on the XW System Control Panel is set to the correct local time.

Value	Description
12:00AM to 11:59PM (12-hour clock)	At the time set for “QT End” the XW Auto Generator Start will be able to automatically start the generator again. If a start trigger has occurred during quiet time and is still active, the generator will start immediately after quiet time ends.
00:00 to 23:59 (24-hour clock)	

Gen Type

- Full name** Generator Type
- Purpose** “Gen Type” is a changeable setting for selecting the starting requirements of the generator. The starting requirements determine how the XW Auto Generator Start must be wired to the generator’s starting system. For more information, see “Connecting the Generator” on page 2–8 or Appendix B.

Important: “Gen Type” can only be changed after the system is put into Standby. See “Putting the XW Auto Generator Start in Standby Mode” on page 4–6.

Table 3-1 Generator Type Descriptions and Examples

Option	Description		
	Mode	For Technical Details, see... ^a	Examples of Generators ^b
Type 1	GlowStop	page 2–9	Generac
Type 2	GlowStop with no preheat	page 2–10	Onan Diesel (Default)
Type 3	GlowStop with shutdown bypass	page 2–11	Generac
Type 4	StartStop with Relay 3 prime	page 2–12	Guardian/Generac Gas
Type 5	StartStop with Relay 3 preheat	page 2–13	Guardian/Generac Diesel

Table 3-1 Generator Type Descriptions and Examples(Continued)

Option	Description		
	Mode	For Technical Details, see... ^a	Examples of Generators ^b
Type 6	GlowStop with normally closed RunStop contact	page 2–14	Yamaha
Type 7	Run with preheat	page 2–15	Generac Backup/Renewable
Type 8	Run with no preheat	page 2–16	Northern Lights and Fisher Panda
Type 9	StartStop with Relay 3 preheat and shutdown bypass	page 2–17	Westerbeke
Type 10	StartStop	page 2–18	Generac
Type 11	MomentaryRun	page 2–19	Kohler
Type 12	GlowStop with no preheat	page 2–20	Onan Propane
Type 13	PulseStop with Relay 3 preheat	page 2–21	PowerTech Diesel

a. See Appendix C, “Relay Timing” for additional information.

b. Examples of generators are suggestions only and do not imply that those generators must be used with the associated generator types.

When to use Use this setting after installing the XW Auto Generator Start hardware. Selecting a suitable “Gen Type” automatically configures the XW Auto Generator Start to work with the ignition system and starting requirements of the generator. Consult the generator manual or contact the generator’s manufacturer for specific generator starting requirements.

Outcomes Selecting a “Gen Type” from the list automatically configures the following settings:

- Preheat time
- Preheat end to crank delay time
- Crank time
- Crank retry time
- Starter Cool Down time
- Generator Cool Down
- Generator Run Signal hold time
- Start tries.

If the presets will not work with the desired generator, it may be necessary to manually configure some of the settings listed above using information from the generator manufacturer. These settings can be changed in the CfgGen Menu on page 3–20.

Cfg Trigger Menu

The Cfg Trigger menu contains the settings for automatically starting and stopping the generator. This menu allows the adjustment of the default settings for battery voltage, thermostat ON/OFF signals, inverter load, and battery charging stage.

There are three classes of triggers: charger-based, thermostat-based, and inverter load-based. If the generator is started by a trigger in one class, a stop condition must also be set in order for the generator to stop. For example for charger triggers, if the generator is started by the “Start DCV 30 sec” condition, any of the accompanying stop triggers “Stop Float”, “Stop Float” and “Stop V” can be used to stop it.

If at least one start trigger is enabled in two or all three trigger classes, the first trigger to be true will start the generator. Conversely, the last stop trigger to be met will stop the generator.

Changing the default settings is advised for experienced users or users who have consulted service personnel.

Important: The Auto Gen Start mode must be set to Manual Off before any start trigger parameters are set.

The Cfg Trigger menu contains the following items.

Charger Triggers:

- “Start DCV 30 sec”
- “Start DCV 15 min”
- “Start DCV 2 hr”
- “Start DCV 24 hr”
- “Stop Float”
- “Stop Absorb”
- “Stop V”

Thermostat Triggers:

- “Temp1”
- “Temp2”

Inverter Load Triggers:

- “Load”
- “Start Load”
- “Stop Load”

Start DCV 30 sec

- Full Name** Starting Battery Voltage—30 seconds
- Purpose** The “Start DCV 30 sec” trigger enables the XW Auto Generator Start to start the generator whenever the battery voltage reaches or drops below a pre-set voltage for longer than 30 seconds.
- The XW Auto Generator Start will stop the generator when the stop trigger is provided (“Stop V”, “Stop Absorb”, or “Stop Float”).
- Dependencies** The “Start DCV 30 sec” trigger requires the XW Auto Generator Start to be in Automatic mode and needs the “Stop Absorb” or “Stop Float” trigger be enabled or a parameter to be set for the “Stop V” trigger.

Values	Default
Disabled, 4.0 V to 65.0 V(increments of 0.1 V)	44.0 V

- Considerations**
- If the voltage trigger is set too high, the generator will start more frequently than is convenient.
- If the voltage trigger is set too low, the batteries may be damaged by repeated cycles of excessive discharge. The generator running time necessary to charge the batteries may exceed “Max Run Time” and use too much fuel in the process.
- If using the XW Inverter/Charger Low Batt Cut Out voltage setting to trigger a start-on-voltage setting on the XW Auto Generator Start, be sure to set the XW Auto Generator Start voltage trigger higher than the XW Inverter/Charger Low Batt Cut out voltage. Otherwise the inverter output turns off and then back on when the generator auto-starts.
- If using an automatic generator starting system with the start trigger set to the same voltage as the LBCO voltage, do not set the LBCO Delay for less than the amount of time it takes the generator to start and connect. Otherwise, inverter output turns off and then back on when the generator auto-starts.
- Battery Voltage Information** Battery voltage can be monitored from the System screen or the inverter/charger menu.
- If “Stop Float” or “Stop Absorb” has been enabled, the generator will stop when the Float or Absorption stages of the battery charging have begun.
- If the “Stop V” is used, the generator will stop when the battery voltage reaches the parameter set in this trigger, regardless of whether the batteries are charged.

Start DCV 15 min

Full Name Starting Battery Voltage—15 minutes

Purpose The “Start DCV 15 min” trigger enables the XW Auto Generator Start to start the generator whenever the battery voltage reaches or drops below a pre-set voltage for longer than 15 minutes.

The XW Auto Generator Start will stop the generator when the battery voltage has risen to the “Stop V”, or when the batteries have been recharged to the Absorption or Float stage.

Dependencies The “Start DCV 15 min” trigger requires the XW Auto Generator Start to be in Automatic mode and needs the “Stop Absorb” or “Stop Float” trigger be enabled or a parameter to be set for the “Stop V” trigger.

Values	Default
Disabled, 4.0V to 65.0V	Disabled

Considerations If the voltage trigger is set too high, the generator will start more frequently than is convenient.

If the voltage trigger is set too low, the batteries may be damaged by repeated cycles of excessive discharge. The generator running time necessary to charge the batteries may exceed “Max Run Time” and use too much fuel in the process.

Battery Voltage Information Battery voltage can be monitored from the System screen or the inverter/charger menu.

If “Stop Float” or “Stop Absorb” has been enabled, the generator will stop when the Float or Absorption stages of the battery charging have begun.

If the “Stop V” is used, the generator will stop when the battery voltage reaches the parameter set in this trigger, regardless of whether the batteries are charged.

Start DCV 2 hr

- Full name** Starting Battery Voltage—2 hours
- Purpose** The “Start DCV 2 hr” trigger enables the XW Auto Generator Start to start the generator whenever the battery voltage reaches or drops below a pre-set voltage for longer than 2 hours.
- Dependencies** The “Start DCV 2 hr” trigger requires the XW Auto Generator Start to be in Automatic mode and needs the “Stop Absorb” or “Stop Float” trigger be enabled or a parameter to be set for the “Stop V” trigger.

Values	Default
Disabled, 4.0 V to 65.0 V	Disabled

- Considerations** If the voltage trigger is set too high, the generator will start more frequently than is convenient.
- If the voltage trigger is set too low, the batteries may be damaged by repeated cycles of excessive discharge. The generator running time necessary to charge the batteries may exceed “Max Run Time” and use too much fuel in the process.
- Battery Voltage Information** Battery voltage can be monitored from the System screen or the inverter/charger menu.
- If “Stop Float” or “Stop Absorb” has been enabled, the generator will stop when the Float or Absorption stages of the battery charging have begun.
- If the “Stop V” is used, the generator will stop when the battery voltage reaches the parameter set in this trigger, regardless of whether the batteries are charged.

Start DCV 24 hr

Full name	Starting Battery Voltage—24 hours
Purpose	The “Start DCV 24 hr” trigger enables the XW Auto Generator Start to start the generator whenever the battery voltage reaches or drops below a pre-set voltage for longer than 24 hours.
Dependencies	The “Start DCV 24 hr” trigger requires the XW Auto Generator Start to be in Automatic mode and needs the “Stop Absorb” or “Stop Float” trigger be enabled or a parameter to be set for the “Stop V” trigger.

Values	Default
Disabled, 4.0 V to 65.0 V	Disabled

Considerations	<p>If the voltage trigger is set too high, the generator will start more frequently than is convenient.</p> <p>If the voltage trigger is set too low, the batteries may be damaged by repeated cycles of excessive discharge. The generator running time necessary to charge the batteries may exceed “Max Run Time” and use too much fuel in the process.</p>
Battery Voltage Information	<p>Battery voltage can be monitored from the System screen or the inverter/charger menu.</p> <p>If “Stop Float” or “Stop Absorb” has been enabled, the generator will stop when the Float or Absorption stages of the battery charging have begun.</p> <p>If the “Stop V” is used, the generator will stop when the battery voltage reaches the parameter set in this trigger, regardless of whether the batteries are charged.</p>

Stop Float

Full name Stop at Float Charge Stage

Purpose The “Stop Float” trigger allows the XW Auto Generator Start to stop the generator when the inverter/charger has recharged the batteries to the Float stage.

Values	Default
Disabled, Enabled	Enabled

Considerations “Stop Float” or “Stop Absorb” would typically be used if the generator was started due to a low-battery voltage setting.

“Stop Float” is the recommended setting if it is desired that the generator charge the batteries completely. This will result in somewhat longer run times. However, if the generator is the primary charging source, charging them to the Float stage every time will provide longer battery life.

For more information on battery charging, see the XW Inverter/Charger Operator’s Guide.

Stop Absorb

Full name Stop at Absorption Charge Stage

Purpose The “Stop Absorb” triggers enables the XW Auto Generator Start to stop the generator when the inverter/charger has recharged the batteries to the Absorption stage.

Values	Default
Disabled, Enabled	Disabled

Considerations Set “Stop Absorb” if it’s desired to only deliver a partial charge to the batteries. The XW Auto Generator Start will start and run the generator until the inverter/charger charges the batteries through the Bulk charge stage (restoring the batteries between roughly 75% and 90% of their full charge). The XW Auto Generator Start stops the generator when the inverter/charger determines the batteries have reached the Absorption charge stage.

Because Stop Absorption will shut down the generator before the batteries are fully charged, it is recommended to use it only if there is an alternate charging source, such as wind or PV, which can complete the

charge. If the generator is the only charging source, Stop Absorption will leave the batteries consistently undercharged and may shorten the battery life. Alternately, Stop Absorption can be useful during utility outages, when it is desired to keep the generator run time to a minimum, but are expecting a full recharge once the power is restored.

For more information on battery charging, see XW Inverter/Charger Operator’s Guide.

Stop V

Full name Stopping Battery Voltage

Purpose The “Stop V” trigger enables the XW Auto Generator Start to stop the generator whenever the battery voltage reaches a pre-set DC voltage. Whenever the generator starts automatically based on the Starting Battery Voltage, it will shut off once the Stopping Battery Voltage has been reached.

Dependencies The “Stop V” trigger requires the XW Auto Generator Start to be in Automatic mode and needs a parameter to be set for one of the Start DCV triggers.

Values	Default
Disabled, 14.0 V to 60.0 V (increments of 0.1 V)	Disabled

Considerations The “Stop V” setting is most useful when you want the inverter/charger to give the batteries a quick, basic charge. If using this mode, it is recommended to run a complete charge or equalize cycle once in a while to restore the battery. To give the batteries a more complete, consistent charge, use the “Stop Float” setting. This will result in longer generator run times.

If “Stop V” is set too high, the generator may run for too long.

If “Stop V” is set too low, the XW Auto Generator Start will stop the generator before the inverter/charger has charged the batteries.

If “Stop Float” or “Stop Absorb” have been enabled, the XW Auto Generator Start will stop the generator if the Float or Absorption stages of the battery charging have begun.

Actual battery voltage can be monitored from the XW System Home screen on the XW System Control Panel.

For more information on battery charging, see the XW Inverter/Charger Operator’s Guide.

Temp1

Full name Thermostat 1

Purpose The “Temp1” trigger enables the generator to start in response to a signal from a thermostat. With “Temp1” set to [Enabled], the XW Auto Generator Start will start the generator to help power the item controlled by that thermostat.

Values	Default
Disabled, Enabled	Disabled

When to use Enable this setting if a thermostat is available that controls a component that has a high-power requirement such as a furnace or an air conditioning system.

Considerations If this setting is enabled, the generator will start in response to a signal from the thermostat. Everything related to setting the thermostat must be done on the thermostat. For example: setting the temperature at which the furnace or air conditioning system comes on must be done on the thermostat. There are no thermostat temperature settings on the XW Auto Generator Start or the XW System Control Panel.

If this setting is disabled, the component connected to that thermostat will require that the generator be started manually in order for that component to have power. Otherwise, the component will need to be connected to another AC input source.

Temp2

Full name Thermostat 2

Purpose “Temp2” is intended to be used when the XW Auto Generator Start is connected to a second thermostat. All information and procedures for “Temp1” also apply for “Temp2”.

Values	Default
Disabled, Enabled	Disabled

Load

Full name Enable Inverter Load Start and Stop Triggers

Purpose The “Load” trigger enables or disables the Start on Inverter Load Current and Stop on Inverter Load Current functionality of the XW Auto Generator Start. This function enables the generator to start and stop based on the current being drawn on the inverter by the loads. See “Start Load” and “Stop Load” on page 3–20.

Dependencies The “Load” trigger requires the XW Auto Generator Start to be in Automatic mode and needs parameters to be set for both the “Start Load” and “Stop Load” triggers.

Value	Default
Disabled, Enabled	Disabled

Important: This function is intended to protect the batteries from rapid drain. It is not intended to protect the inverter against overload.

Start Load

Full name Start on Inverter Load Current

Purpose The “Start Load” trigger enables the generator to start at a specified AC load (current draw) on the inverter. This current draw must be present for 5 minutes before the generator will start. The generator will assist the inverter with powering the AC load.

Dependencies The “Start Load” trigger requires the XW Auto Generator Start to be in Automatic mode and the “Load” trigger to be set to ON. It also needs to have a stopping value set in the “Stop Load” trigger.

Values	Default
10.0 A to 33.0 A (increments of 1A)	10.0 A

Considerations Change this setting if there are certain “peak” times of power usage or if power demands consistently exceed the output of the inverter.

If “Load” is set to [Enabled], the generator will start in response to the “Start Load” setting unless the XW Auto Generator Start is in a Quiet Time period.

The inverter load current can be monitored on the System screen.

If “Start Load” is set too high, the XW Auto Generator Start may not start the generator in time to recharge the batteries before the batteries are drained by the AC load. In addition, if “Start Load” is set too high, the inverter may shut down due to an overload condition.

If “Start Load” is set too low, the XW Auto Generator Start may start the generator too frequently, wasting fuel in the process.

Stop Load

Full name	Stop on Inverter Load Current
Purpose	The “Stop Load” trigger enables the XW Auto Generator Start to stop the generator when the AC load falls below a specific level for 1 minute. The “Stop Load” setting applies to situations when the XW Auto Generator Start has started the generator to assist the inverter with powering the AC load.
Dependencies	The “Stop Load” trigger requires the XW Auto Generator Start to be in Automatic mode and the “Load” trigger to be set to [Enabled]. It also needs to have a value starting value set in the “Start Load” trigger.

Values	Default
7.0 A to 28.0 A (increments of 1 A)	7.0 A

Cfg Gen Menu

The Cfg Gen Menu provides the means to customize the following settings if the generator being used doesn't conform to one of the preset generator types or if an exercise period needs to be scheduled.

The Generator Configuration menu contains the following items:

- “Starter Cool Down”
- “Gen Cool Down”
- “Max Run Time”
- “Exercise Per”
- “Exercise Dur”
- “Exercise Time”
- “Relay3”
- “Gen Run Hold Time”
- “Crank Delay”
- “Crank Time”
- “Crank Retry Time”
- “Preheat Time”
- “Gen Start Tries”

Starter Cool Down

Purpose The Starter Cool Down setting allows an interval to be set between start attempts if the generator fails to start on the first attempt. This time period allows the start motor to cool sufficiently before the XW Auto Generator Start signals it to begin cranking again.

Values	Default
1s to 250s (increments of 1s)	60s

When to use This setting is automatically configured when a “Gen Type” is selected for the generator. Customize the “Starter Cool Down” trigger on the advice of the generator manufacturer or authorized service personnel.

Gen Cool Down

Purpose The Gen Cool Down setting allows an interval to be set between a generator stop trigger occurring and the AGS actually stopping the generator. This setting is used in XW system to unload the generator before the AGS shuts it down. When a stop trigger occurs, the AGS enters a Generator cool down state where it continues to run the generator for the specified time period. At the same time the XW inverter/charger will disconnect the generator when it detects the AGS in Generator Cool Down, allowing the generator operate unloaded and cool down before it is shut down.

This helps improve reliability of the generator by reducing temperature peaking due to abrupt shut down of a loaded generator. It also reduces the probability of the generator backfiring that typically happens when the generator is abruptly shutdown while under heavy load. Gen Cool Down applies to all stop triggers namely Stop V, Stop Load, Stop float, Stop Absorb, Stop Load, and Manual Off.

Values	Default
1s to 90s (increments of 1s)	30s

When to use This setting is automatically configured when a “Gen Type” is selected for the generator. Customize the “Gen Cool Down” trigger on the advice of the generator manufacturer or authorized service personnel.

Max Run Time

Full name Maximum Generator Run Time

Purpose “Max Run Time” allows a limit to be set on how long the generator will run. This setting overrides any automatic start triggers. For example, if the generator starts in response to low battery voltage, and the batteries are not fully charged before “Max Run Time” is reached, the generator will stop. In addition, when the generator is started manually from the XW System Control Panel, the generator will stop when “Max Run Time” is reached.

When started with an external manual ON/OFF switch, the generator will not stop when it reaches “Max Run Time”. The generator must be stopped with the external manual ON/OFF switch, or by using the System Control Panel to change the “GenMode” to ManualOff.

If the XW Auto Generator Start reaches “Max Run Time”, a warning message will appear on the XW System Control Panel. The XW Auto Generator Start will stop operating until the warning is acknowledged by pressing ENTER on the XW System Control Panel.

Values	Default
0 hours to 24 hours (increments of 1 hour)	8 hours

Considerations Adjust the “Max Run Time” if the maximum generator run time:

- exceeds the fuel capacity of the generator, or
- is not long enough to fully recharge the batteries under optimum conditions.

Exercise Per

Full name Set Exercise Period (in days).

Purpose “Exercise Per” sets the minimum time interval between each running of the generator. If the generator has not been run within this time frame, the XW Auto Generator Start will start the generator to “exercise” it.

The time interval defined by the Exercise Period setting begins with the last time the generator was run for any reason, not with the last time the XW Auto Generator Start exercised the generator.

For example, setting an exercise period of 30 days would start the generator if it had not been run at all for 30 days.

Dependencies The “Exercise Per” trigger requires parameters to be set in the “Exercise Dur” and “Exercise Time” menu items.

Values	Default
0 (Off), 1day to 250days (increments of 1day)	21days

Considerations Generators need to run regularly in order to maintain mechanical health and performance. If the generator isn’t needed and doesn’t run, it is recommended that an Exercise period be set to keep the generator in good working condition.

If the generator runs frequently throughout the year, it may not need to set an exercise period. In that case, set the “Exercise Per” trigger to 0.

Important: Consult the generator manual or a service representative from the generator’s manufacturer for the recommended exercise period.

Exercise Dur

Full name Exercise Duration (in minutes)

Purpose “Exercise Dur” sets how long the generator will run when it is exercised.

Dependencies The “Exercise Dur” trigger requires that any parameter other than “0” be set in “Exercise Per” and a time of day be set in the “Exercise Time” trigger.

Values	Default
1min to 250min	30min

Important: Ensure that the Exercise Duration is not set for longer than the “Max Run Time” setting. Attempting to do so will generate a warning on the System Control Panel.

Important: Consult the generator manual or a service representative from the generator’s manufacturer for the recommended exercise duration.

Exercise Time

Purpose “Exercise Time” sets the time of day that the XW Auto Generator Start exercises the generator.

The “Exercise Time” trigger requires that any parameter other than “0” be set in “Exercise Per” and a value be set in the “Exercise Dur” trigger.

Values	Default
12:00AM to 11:50PM (12-hour clock) 00:00 to 23:50 (24-hour clock) (increments of 10 minutes)	9:00AM

Considerations If the Exercise Time is set, the generator will start at that time after being inactive for the Exercise Period.

If the Exercise Time occurs during Quiet Time, the generator will start when Quiet Time is over and run for the full amount of time set for “Exercise Dur”.

Relay3

Purpose “Relay3” sets the function of Relay 3 of the XW Auto Generator Start. The function of Relay 3 affects contacts 19 and 20 of the 20-contact connector and external wiring harness.

Values	Default
NotUsed, Preheat, PreheatSDByp	NotUsed

Considerations Selecting a value for “Gen Type” automatically configures “Relay3”. It might be necessary to manually set “Relay3” according to the make and type of generator being used.

Some diesel generators require preheating of their glow plugs before start cranking. Setting “Relay3” to Preheat enables Relay 3 to perform this function in addition to Relay 1.

Some generators require Relay 3 to switch 12 volts to the glow plugs, while some generators require ground to be switched to the glow plugs.

“PreheatSDByp” stands for Preheat with Shutdown Bypass. Some generators require preheat on relay 3 to remain high for crank time and shutdown bypass period. See “GlowStop Mode” on page C-4 for more details.

Gen Run Hold Time

Full name Generator Run Signal Hold Time

Purpose “Gen Run Hold Time” specifies the length of time the generator run signal (or B+ or hour meter signal) must be active before the XW Auto Generator Start considers the generator to be running and cranking can be stopped.

Some generators assert their run signal when they are being cranked, but before they have started. They also have varying delays from when cranking begins or ends to when the run signal is asserted or unasserted. The Run Hold Time is designed to accommodate these generators.

Values	Default
0.0s to 20.0s (increments of 0.5s)	0.5s

Considerations This setting is automatically configured when a “Gen Type” is selected for the generator. Manually change this setting only on the advice of the generator manufacturer or authorized service personnel.

Crank Delay

Purpose “Crank Delay” specifies the delay time from when the preheat relay is de-energized to when the Start Relay is energized (and cranking the starter motor). This is also referred to as the preheat-to-crank delay.

Values	Default
0s to 250s	1s

Considerations This setting is automatically configured when a “Gen Type” is selected for the generator. Manually change this setting only on the advice of the generator manufacturer or authorized service personnel.

Crank Time

Purpose “Crank Time” specifies the maximum length of time the Start relay is engaged (and cranking the starter motor) for the first attempt to start the generator.

Values	Default
0s to 250s (increments of 1s)	30s

Considerations This setting is automatically configured when a “Gen Type” is selected for the generator. Manually change this setting only on the advice of the generator manufacturer or authorized service personnel.

Crank Retry Time

Purpose “Crank Retry Time” specifies the length of time the Start relay is engaged (and cranking the starter motor) for the second and subsequent attempts to start the generator, in cases when the generator fails to start on the first attempt.

Values	Default
0s to 250s (increments of 1s)	40s

Considerations This setting is automatically configured when a “Gen Type” is selected for the generator. Manually change this setting only on the advice of the generator manufacturer or authorized service personnel.

Preheat Time

Purpose “Preheat Time” specifies how long the Preheat relay is engaged during the start sequence. The preheat signal may be required for diesel generators with glow plugs or fuel priming for gas generators.

The Preheat relay may be Relay 1 or Relay 3, depending on the “Relay3” setting or the Gen Type selected.

Values	Default
0s to 250s (increments of 1s)	0s

Considerations This setting is automatically configured when a “Gen Type” is selected for the generator. Manually change this setting only on the advice of the generator manufacturer or authorized service personnel.

Gen Start Tries

“Gen Start Tries” specifies how many times the XW Auto Generator Start will attempt to start the generator. On the first start try, the XW Auto Generator Start cranks the starter motor for the Crank Time. If the generator does not start, on subsequent start tries, the XW Auto Generator Start cranks the start motor for the Crank Retry Time.

Values	Default
1 to 10	3

Considerations This setting is automatically configured when a “Gen Type” is selected for the generator. Manually change this setting only on the advice of the generator manufacturer or authorized service personnel.

Multi-unit Config

“Multi-unit Config” provides the means to identify multiple units within the same configuration.

Dev Name

The “Dev Name”, or Device Name, menu item gives each Xanbus-enabled device a unique identifiable name. This makes each device easier to identify when multiple Xanbus-enabled devices are connected together.

See the XW Inverter/Charger Operator’s Guide for additional information.

Dev Number

The “Dev Number”, or Device Number, menu item gives each Xanbus-enabled device a unique identifiable number in addition to the name. This provides the means to use the same name, but different numbers for similar devices (such as MPPT 01 and MPPT02).

See the XW Inverter/Charger Operator’s Guide for additional information.

Connections

The “Connections” menu item identifies the AC and DC input and output sources that affect or control the system (XW Auto Generator Start). Start and stop triggers such as DC Voltage, charge stage, and AC load current, are related to these settings.

DC Conn

The “DC Conn” (DC connection) must be set to match that of the XW inverter/charger(s) in the system. This tells the XW Auto Generator Start which battery bank to use for the charger based triggers. Configuration of this parameter is only necessary for systems with more than one XW inverter/charger and more than one battery bank.

AC In

The “AC In” tells the XW Auto Generator Start what AC source or grid the XW inverter/charger is connected to. The XW Auto Generator Start uses this setting to stop the generator once the XW inverter/charger transfers from the generator to the grid. Configuration of this parameter is only necessary for larger systems with multiple XW inverter/charger and multiple grid connections.

AC Out

The “AC Out” tells the XW Auto Generator Start what load to monitor for AC load triggers. Configuration of this parameter is only necessary for systems with more than one XW inverter/charger.

Generator This generator name is used by the XW inverter/charger to identify which generator is connected to the AC2 input. It is only necessary to change this setting in installations with more than one XW Auto Generator Start in a system. In this case, the “generator” name on each XW Auto Generator Start will have to be unique.

Example: If a generator is connected to AC2 on an XW inverter/charger, the generator name (e.g., Gen1, Gen2 etc.) selected for AC2 under “Connections” on the XW must match the generator name assigned here.

See the XW Inverter/Charger Operator’s Guide for additional information.

Restore Defaults

The “Restore Defaults” returns the XW Auto Generator Start to the factory default settings.

GenMode

Purpose The GenMode menu item controls the current operating mode of the XW Auto Generator Start.

Value	Description
Automatic	Automatic mode
ManualOn	Manual on mode
ManualOff	Manual off mode (default mode)

Considerations Use GenMode when it is necessary to switch between automatic generator control and manual generator control.

When the Xanbus system powers up all network-enabled devices, the XW Auto Generator Start is in ManualOff mode. To enable automatic generator starts, the XW Auto Generator Start must be put in “Automatic” mode.

Automatic Mode

To have the XW Auto Generator Start start and stop the generator automatically, select Automatic. The generator can start and stop automatically in response to low battery voltage, AC loads on the inverter, thermostat triggers, or exercise time. Automatic mode also has a Quiet

Time feature, which prevents the generator from starting during evening hours or other inconvenient times (see “QT Begin” on page 3–8, “QT End” on page 3–9, and “Using Quiet Time” on page 4–4).

Automatic Mode Overrides

When the XW Auto Generator Start is in Automatic mode, several settings and conditions override automatic start and stop triggers. These overrides include, in order of priority:

- **Faults**—The XW Auto Generator Start stops the generator when a fault occurs.
- **External Shutdown**—When the XW Auto Generator Start is connected to a sensor or meter (a moisture detector, for example) wired to contacts 5 and 6 of the 20-contact connector, it stops the generator when the device is activated. See “Connecting an External Shutdown (optional)” on page 2–22.
- **External On/Off**—The generator is manually started or stopped with a switch wired to contacts 7 and 8 of the 20-contact connector. See “Connecting an External Manual ON/OFF Switch (optional)” on page 2–23. When started with an external manual ON/OFF switch, the generator will not stop when it reaches Max Run Time. The generator must be stopped using the external manual ON/OFF switch.
- **Max Run Time**—When the generator has exceeded its maximum run time, a warning message will appear on the XW System Control Panel. The XW Auto Generator Start will stop operating until the warning is acknowledged by pressing Enter on the XW System Control Panel. See “Max Run Time” on page 3–22.
- **Manual On**—The generator is started by selecting Manual On mode.
- **Manual Off**—The generator is stopped by selecting Manual Off mode.

Manual On Mode

Selecting Manual On Mode overrides the automatic start settings and manually starts the generator. The generator will run until it is manually stopped or until it reaches its XW Auto Generator Start-defined Maximum Run Time (see “Max Run Time” on page 3–22).

Manual Off Mode

Selecting Manual Off Mode overrides the automatic stop settings and manually stops the generator. Manual Off must be selected to stop the generator when the generator has been started manually. The XW Auto Generator Start will not automatically start the generator again until “Automatic” is selected in the GenMode Menu.

Important: The GenMode mode must be set to Manual Off before any start trigger parameters can be changed.

Mode

The Mode menu item is a device operating mode and provides the means to put the XW Auto Generator Start in Standby Mode or return it from to Operating Mode.

The AGS Mode must be set to [Standby] before selecting a generator type. Selecting Standby stops the generator (if it is running).

While in Standby, the XW Auto Generator Start “listens” to and reports its status to the network. It will not start the generator manual or automatically while in Standby.

The View Device Info Menu

The View Device Info menu provides a means to view the Fault, Warning and Event logs. It is also where the settings can be restored to factory default settings.

View Fault Log

- | | |
|-------------|---|
| Purpose | The Fault Log displays the last 20 XW Auto Generator Start faults for reference to assist the user in troubleshooting problems. |
| When to use | Consult the Fault Log when troubleshooting or before seeking technical assistance. |

View Warning Log

- | | |
|-------------|--|
| Purpose | The Warning Log displays the last 20 XW Auto Generator Start warnings for reference. |
| When to use | Consult the Warning Log when troubleshooting or before seeking technical assistance. |

View Event Log

Purpose

The Event Log displays the last 20 XW Auto Generator Start events for reference. Events can include:

- Starting and stopping the generator.
- Trigger events. See Table 3-2 for a detailed list of trigger events.
- Changing the system mode.
- Changing the system clock.
- Commands to restore the default settings.

Table 3-2 Trigger Event Descriptions

Event Displayed	Description of Event Trigger
NotOn	Generator is not running
LowBattV	Preset minimum battery voltage with associated time delay
CntctClosed	Activated thermostat 1 or 2
ACIHigh	Preset maximum inverter load current
Exercise	Preset exercise period, exercise time, and exercise duration
ManualOn	Started manually using System Control Panel
ExtOnviaAGS	Started by external switch connected to XW Auto Generator Start
ExtOnviaGen	Started by switch connected to generator
UnableToStop	XW Auto Generator Start has lost control of the running generator

User Settings

Use this table to record any customized XW Auto Generator Start settings for future reference.

Table 3-3 Generator Configuration Settings, Values, Defaults, and User Settings

Setting	Values	Default	User Setting
Main Menu Items:			
GenMode	ManualOn, ManualOff, Automatic	ManualOff	
Mode	Operating/Standby	Operating	
Configuration Menu Items:			
“QT En”	Enabled, Off	Enabled	
“QT Begin”	12:00AM–11:59PM (12-hour clock) 00:00–23:59 (24-hour clock)	9:00PM (12-hour clock) 21:00 (24-hour clock)	
“QT End”	12:00AM–11:59PM (12-hour clock) 00:00–23:59 (24-hour clock)	8:00AM (12-hour clock) 8:00 (24-hour clock)	
“Gen Type”	Type 1 to Type 13	Type 2	
Triggers Menu Items:			
“Start DCV 30 sec”	Disabled, 4.0 V–65.0 V	44.0 V	
“Start DCV 15 min”	Disabled, 4.0 V–65.0 V	Disabled	
“Start DCV 2 hr”	Disabled, 4.0 V–65.0 V	Disabled	
“Start DCV 24 hr”	Disabled, 4.0 V–65.0 V	Disabled	
“Stop Float”	Enabled, Disabled	Disabled	
“Stop Absorb”	Enabled, Disabled	Enabled	
“Stop V”	Disabled, 4.0 V–65.0 V	Disabled	
“Temp1”	Enabled, Disabled	Disabled	
“Temp2”	Enabled, Disabled	Disabled	
“Load”	Enabled, Disabled	Disabled	
“Start Load”	10.0 A–33.0 A	10.0 A	
“Stop Load”	7.0 A–28.0 A	7.0 A	

Table 3-3 Generator Configuration Settings, Values, Defaults, and User Settings

Setting	Values	Default	User Setting
Generator Menu Items:			
“Starter Cool Down”	1s to 250s (increments of 1s)	60s	
“Gen Cool Down”	0s to 90 s (increments of 1s)	30s	
“Max Run Time”	0hours–24 hours	8hours	
“Exercise Per”	0days (Off)–250days	21days	
“Exercise Dur”	1min–250min	30min	
“Exercise Time”	12:00AM–11:59PM (12-hour clock) 00:00–23:59 (24-hour clock)	9:00AM (12-hour clock) 9:00 (24-hour clock)	
“Relay3”	Preheat, WrmupCoolDn, Preheat SDByp, NotUsed	NotUsed	
“Gen Run Hold Time”	0.5s to 20s (increments of 1s)	0.5s	
“Crank Delay”	0s to 60s (increments of 1s)	0s	
“Crank Time”	0s to 250s (increments of 1s)	30s	
“Crank Retry Time”	0s to 250s (increments of 1s)	40s	
“Preheat Time”	0s to 250s (increments of 1s)	0s	
“Gen Start Tries”	1 to 10	3	
Multi-Unit Configuration:			
“Dev Name”	1-15 characters	XW AGS	
“Dev Number”	00 to 31	00	
Connections:			
“DC Conn”	None, HouseBatt1 to 6, StartBatt1 to 6	HouseBatt1	
“AC In”	None, Grid1to 10, Gen1 to 10	Grid1	
“AC Out”	None, ACLoad1 to 10	ACLoad1	
“Generator”	Gen1 to 10	Gen1	

4

Operation

Chapter 4, “Operation” describes the operation of the XW Auto Generator Start and how to get the most from its features.

For this Topic....	See....
“Accessing the XW Auto Generator Start Home Screen”	page 4–2
“Starting and Stopping the Generator”	page 4–3
“Using Quiet Time”	page 4–4
“Modes of Operation”	page 4–5
“Putting the XW Auto Generator Start in Standby Mode”	page 4–6

Accessing the XW Auto Generator Start Home Screen

Use the XW Auto Generator Start Home Screen to view basic operational status information for the generator. The XW Auto Generator Start Home Screen displays the generator start settings (i.e., ManualOff), the generator state (running or stopped), the stop trigger, and the Generator signal.

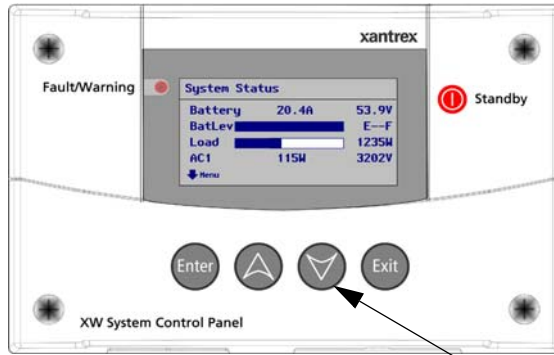

XW System Home Screen

Press the Down Arrow button until the AGS Home Screen is displayed.

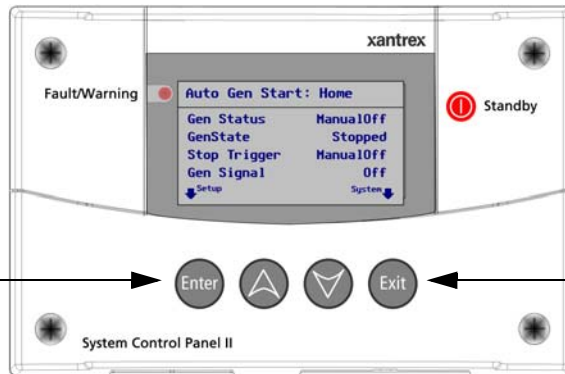

XW Auto Generator Start Home Screen

When the XW Auto Generator Start Home screen is displayed, press the Enter button to move into the XW Auto Generator Start Setup Menu.

Press the Exit button to move back to the XW System Home Screen.

Figure 4-1 XW Auto Generator Start Home Screen

Starting and Stopping the Generator

Use the XW Auto Generator Start to start or stop the generator manually using the XW System Control Panel or automatically in response to an electrical system condition.

To set the XW Auto Generator Start to start and stop the generator automatically:

1. On the XW Auto Generator Start menu, highlight GenMode and press Enter.
2. Use the navigation button to select [Automatic].
3. Press Enter.

To start the generator manually:

1. On the XW Auto Generator Start menu, highlight GenMode and press Enter.
2. Use the navigation button to select [ManualOn].
3. Press Enter.

To stop the generator manually:

1. On the XW Auto Generator Start menu, highlight GenMode and press Enter.
2. Use the navigation button to select [ManualOff].
3. Press Enter.

Important: To avoid XW Auto Generator Start faults, try not to combine automatic and external manual starts and stops.

When the generator has been started automatically, allow it to stop automatically unless a situation occurs that requires the generator to be stopped urgently.

Likewise, if the generator has been started manually, ensure that it is stopped manually. Only the “Max Run Time” setting can automatically stop the generator after it has been started manually.



Figure 4-2 Starting and Stopping the Generator

Using Quiet Time

Use the Quiet Time feature to ensure that the XW Auto Generator Start will not start the generator during the night or during times that conflict with local noise restrictions.

Using Quiet Time involves three steps.

1. “QT En” must be set to [Enabled]. The default setting is [Enabled].
2. “QT Begin” must have an appropriate time set for Quiet Time to start on schedule. The default setting for “QT Begin” is [9:00 PM] or 21:00 if using a 24-hour clock.
3. “QT End” must have an appropriate time set for Quiet Time to stop on schedule. The default setting for “QT End” is [8:00 AM] or 8:00 on the 24-hour clock.

For more information about Quiet Time settings, see “QT En” on page 3–7, “QT Begin” on page 3–8, and “QT End” on page 3–9.

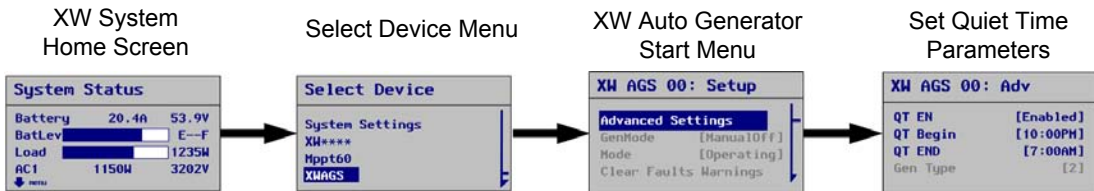

Figure 4-3 Using the Quiet Time Feature

To enable Quiet Time:

1. On the Auto Gen Start menu, use the navigation buttons to highlight “QT En”.
2. Press Enter.
3. Use the navigation buttons to select [Enabled].
4. Press Enter.

To set the beginning of Quiet Time:

1. On the Auto Gen Start menu, use the navigation buttons to highlight “QT Begin”, then press Enter.
2. Use the navigation buttons to select the hour, then press Enter.

3. Use the navigation buttons to select the minutes, then press Enter. If the 24-hour clock is being used, go to step 5.
4. Use the navigation buttons to select AM or PM, then press Enter.
5. Press Exit twice to return to the System Home screen.

To set the end of Quiet Time:

1. On the Auto Gen Start menu, use the navigation buttons to highlight “QT End”, then press Enter.
2. Use the navigation buttons to select the hour, then press Enter.
3. Use the navigation buttons to select the minute, then press Enter. If the 24-hour clock is being used, go to step 5.
4. Use the navigation buttons to select AM or PM, then press Enter.
5. Press Exit twice to return to the System screen.

Modes of Operation

The XW Auto Generator Start, like all other Xanbus-enabled devices, supports two modes, Operating and Standby. The XW Auto Generator Start mode of operation must be set to Standby before selecting a Generator Type. Selecting Standby stops the generator (if it is running).

While in Standby, the XW Auto Generator Start “listens” to and reports its status to the network. However, it will not start the generator manually or automatically while in Standby.

If the XW Auto Generator Start is powered off while in Standby, it will be in Standby when it is powered on again.

The XW Auto Generator Start can also be put in Standby using the system mode option under system settings. However, note that selecting Standby from system settings affects the behavior of the entire XW system.

System mode Standby puts every Xanbus-enabled device in XW Power System into Standby.

Important: If XW Auto Generator Start Fault 201 “Unable to stop gen.” is active, the XW Auto Generator Start cannot be put into Standby. Before Standby can be established, the generator must be stopped by its external switch and the fault must be cleared.

Putting the XW Auto Generator Start in Standby Mode

Use the XW System Control Panel to put the XW Auto Generator Start into Standby mode.

To put the XW Auto Generator Start in Standby Mode:

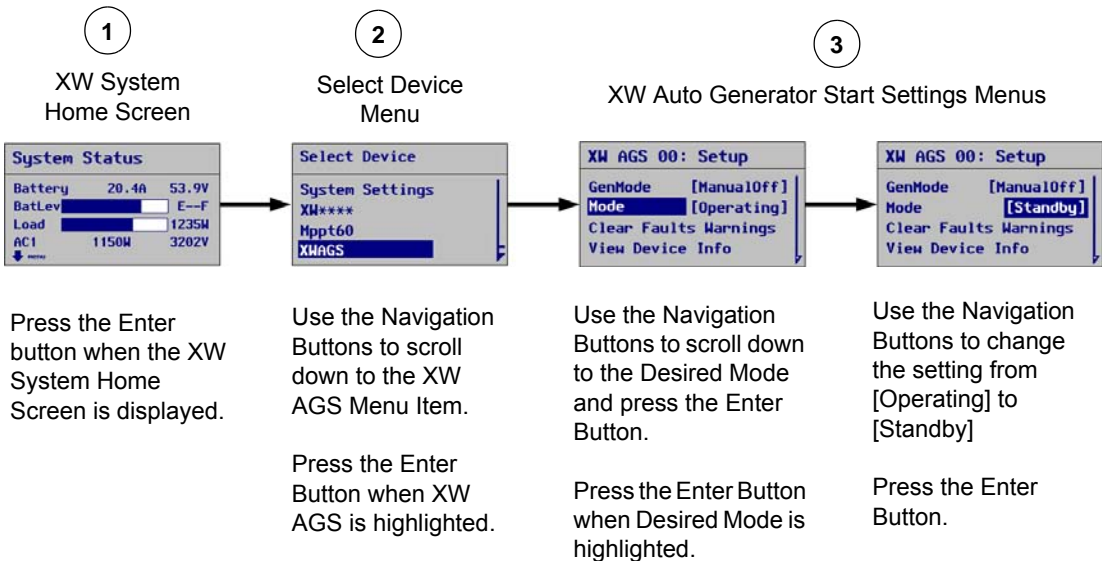
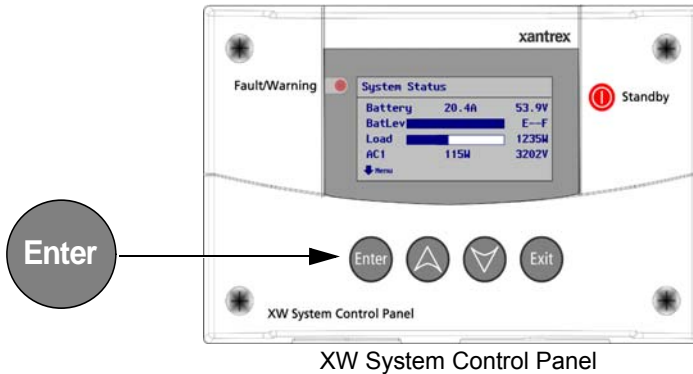

Figure 4-4 Changing the Mode to Standby

Returning the XW Auto Generator Start to Operating Mode

Use the XW System Control Panel to return the XW Auto Generator Start to Operating mode.

To Return the XW Auto Generator Start to Operating Mode:

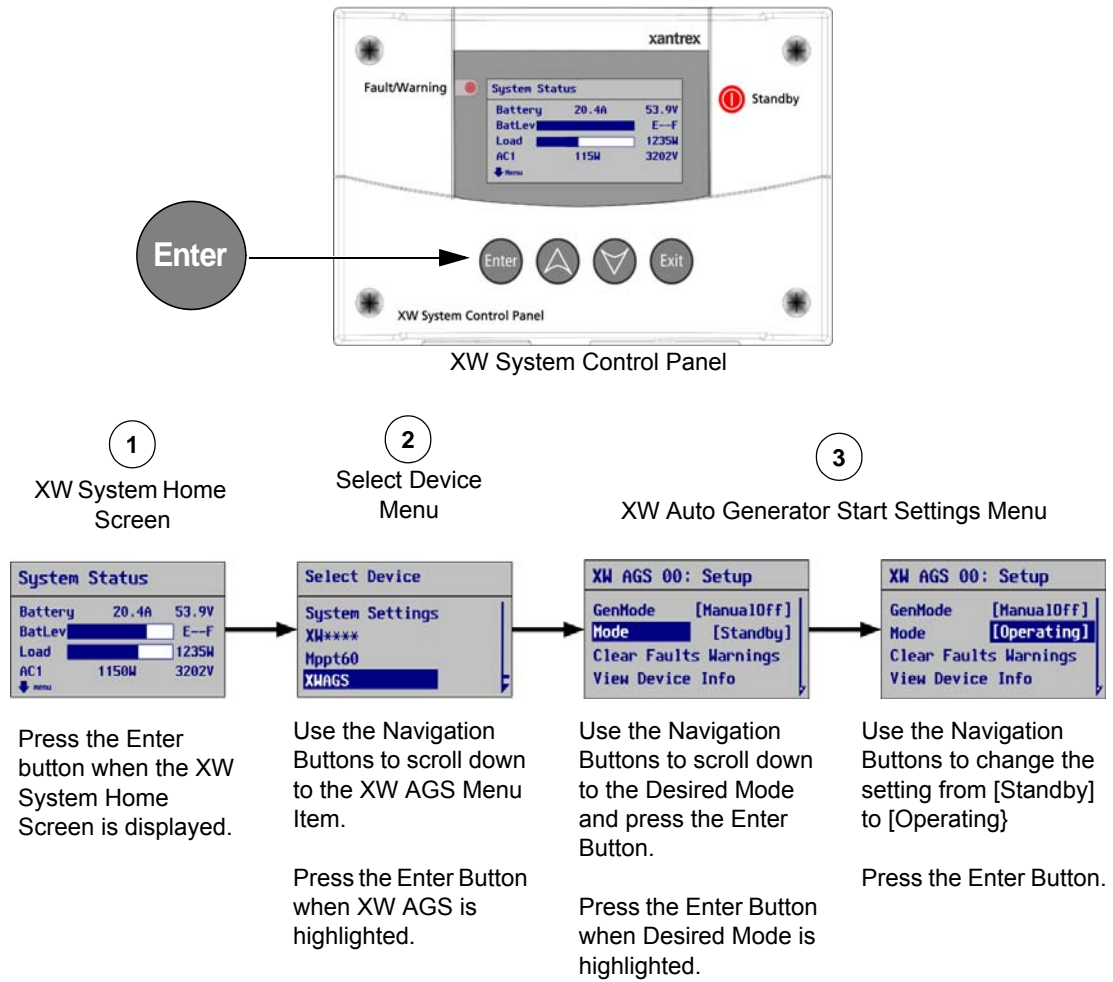

Figure 4-5 Returning the Mode to Operating

5

Troubleshooting

Chapter 5, “Troubleshooting” contains information and procedures to troubleshoot the XW Automatic Generator Start.

For this Topic....	See....
“Faults and Warnings”	page 5-2
“Warning Messages”	page 5-3
“Fault Messages”	page 5-6

Faults and Warnings

Under certain conditions, the XW Auto Generator Start generates a fault or warning message. These messages appear on the XW System Control Panel.

Acknowledging messages

When a fault or warning message appears, it will remain on the screen until it is acknowledged by pressing Enter on the XW System Control Panel. This action removes the message from the screen, but does not clear the condition that caused the fault or warning.

Consult Table 5-1 and Table 5-2 for recommendations for resolving the fault after it has been acknowledged.

Warnings that are in the form of a Yes/No question can be acknowledged by pressing Enter for Yes and Exit for No.

Self-clearing warnings

If unacknowledged, some warnings may clear themselves if the condition that generated the message goes away. For example, if the XW Auto Generator Start fails to start the generator, warning message W202 appears. However, if the generator starts on the next start try, the message goes away.

Clearing faults

To clear active XW Auto Generator Start faults, highlight Clear Faults on the XW Auto Generator Start menu and press Enter.

Multiple faults and warnings

If several fault or warning messages occur before they can be acknowledged or cleared, they are displayed together on a fault list or a warning list. These lists contain messages from every Xanbus-enabled device, not just the XW Auto Generator Start. Message details can be selected and viewed from the fault list or warning list.

To view a message from a fault list or warning list:

1. On the list, use the navigation buttons to highlight the message to be viewed.
2. Press Enter.

The complete message appears.

To return to the fault list or warning list, press Exit.

To continue to the menu for the device that caused the fault or warning condition by pressing Exit.

Each time you return to the list after viewing a complete message, the viewed message is removed from the list.

If you have left the fault list or warning list, you can view them at any time from the System Settings menu.

To view a fault list or warning list:

1. On the Select Device menu, highlight System and press Enter.
2. On the System Settings menu, highlight View Fault List or View Warning List.
3. Press Enter.

Warning Messages

Table 5-1 provides details and suggests action for XW Auto Generator Start warnings.

Table 5-1 XW Auto Generator Start Warning Messages

Warning Number	Message	Self-clearing?	Cause	Action
W200	Generator was stopped manually.	No	Generator was stopped by an external Manual Off switch.	Acknowledge the warning. To resume automatic starts and stops, change the XW Auto Generator Start mode to [Automatic].
W201	Generator was started manually.	No	Generator was started by an external Manual On switch	Acknowledge the warning. To resume automatic starts and stops, change the XW Auto Generator Start mode to [Automatic].
W202	Unable to start generator. XW Auto Generator Start will try again.	Yes	The XW Auto Generator Start tried, but could not start the generator.	No action required. The XW Auto Generator Start will try to start the generator again until it reaches the maximum number of start tries.

Table 5-1 XW Auto Generator Start Warning Messages(Continued)

Warning Number	Message	Self-clearing?	Cause	Action
W203	Manual Off: Max generator run time reached. Reset GenMode.	No	The generator has run for its maximum allowable time. The XW Auto Generator Start has stopped the generator and changed the GenMode to [ManualOff].	Acknowledge the warning. Return the XW Auto Generator Start to the desired GenMode [Automatic or ManualOn]. Ensure generator has fuel and is supplying the required power for battery charging and loads.
W205	Generator started by its switch. Use its switch to stop.	Yes	The generator was started, but not by the XW Auto Generator Start.	Check your generator. Stop it using the switch or control panel on the generator.
W206	Mismatched triggers. Enable stop trigger or disable start trigger.	No	You have set a start trigger, but not a corresponding stop trigger.	Acknowledge warning and set a stop trigger.
W207	Mismatched triggers. Enable start trigger or disable stop trigger.	No	You have set a stop trigger, but not a corresponding start trigger.	Acknowledge warning and set a start trigger.
W208	Automatic start and stop triggers not enabled. Configure triggers.	No	You are attempting to enter Automatic Mode without setting triggers.	Acknowledge warning and set start and stop triggers.
W209	Gen external stop. Start gen via its control panel.	Yes	The generator has stopped, but not by the XW Auto Generator Start. The generator may have run out of gas, or may have been shut off by a switch on the generator.	Check the generator's fuel level and mechanical condition, then start the generator manually (using the switch or control panel on the generator) to clear the warning.

Table 5-1 XW Auto Generator Start Warning Messages(Continued)

Warning Number	Message	Self-clearing?	Cause	Action
W250	The selected value failed to change. Try again.	No	You have tried to change the Gen Type without putting the system into Standby first.	Put the system into Standby, change the Gen Type, then return the system to Operating mode.
			You have tried to set the “Exercise Dur” for longer than “Max Run Time,” or “Max Run Time” for less than “Exercise Dur.”	Ensure that “Max Run Time” is set for longer than “Exercise Dur.”
W500	Network connection lost. Check connections.	Yes	The XW Auto Generator Start has lost communications with the network because of a faulty connection or electronic signal disruption.	Check connection between the XW Auto Generator Start and the network.
W501	XW Auto Generator Start has fixed memory problem and restored default settings.	No	The XW Auto Generator Start encountered an internal memory problem upon startup. To remain operational, the XW Auto Generator Start restored its default settings.	Acknowledge the warning and reset configurable settings if necessary.

Fault Messages

When the XW Auto Generator Start detects a fault condition, it stops the generator. The red Fault light also comes on, and the XW System Control Panel displays a fault message.

The XW Auto Generator Start remembers the GenMode that it was in at the time it detected the fault. After you have cleared the fault, the XW Auto Generator Start returns to its last known GenMode.

Table 5-2 XW Auto Generator Start Fault Messages

Fault Number	Message	Self-clearing?	Cause	Action
F200	Exceeded max number of start tries. Check gen, clear fault.	No	The XW Auto Generator Start has tried and failed to start the generator. To prevent draining the start battery, the XW Auto Generator Start will suspend further start attempts.	Check the generator's fuel level and start battery condition. Consult generator manual. Clear fault on System Control Panel screen to allow retry.
F201	Unable to stop gen. Stop gen via its control panel.	No	The XW Auto Generator Start has lost contact with the generator or the generator did not stop after the XW Auto Generator Start sent it a stop signal.	Change the XW Auto Generator Start mode to Manual Off. If this fails to work, stop the generator with the external stop switch. Check generator. Return XW Auto Generator Start to automatic mode to resume automatic starts and stops.
F203	Manual Off: Gen stopped by ext sensor. Reset GenMode.	No	An external sensor connected to the XW Auto Generator Start has stopped the generator and put the XW Auto Generator Start into Manual Off mode.	After the sensor connected to the external shutdown has deactivated, clear the fault and reset the XW Auto Generator Start to the desired mode.

Table 5-2 XW Auto Generator Start Fault Messages

Fault Number	Message	Self-clearing?	Cause	Action
F500	Serial Number Failure, Service Required.	No	The silicon serial ID number has failed and the XW Auto Generator Start has gone into Standby.	Call your dealer or Xantrex.
F501	Memory Failure. Service Required.	No	The XW Auto Generator Start has suffered a non-volatile memory failure.	Call your dealer or Xantrex.
F505	Internal Failure. Service Required.	No	A controller fault has occurred and the XW Auto Generator Start has gone into Standby.	Clear the fault. If the fault persists, call your dealer or Xantrex.

A

Specifications

Appendix A contains the electrical, mechanical, and environmental specifications for the XW Auto Generator Start.

All specifications are subject to change without notice.

For this Topic...	See...
“Electrical Specifications”	page A-2
“Mechanical Specifications”	page A-3
“Environmental Specifications”	page A-4
“Regulatory Compliance”	page A-4

Electrical Specifications

Nominal input network voltage	15 Vdc
Maximum operating current	200 mA @ nominal input network voltage
Relay contact voltage rating	12 Vdc, 30 Vdc max.*
Maximum relay contact current	5 A DC*
Nominal 12/24 V thermostat input voltage	12 Vdc/24 Vdc* = On
Minimum 12/24 V thermostat input voltage	9.5 Vdc*
Maximum 12/24 V thermostat input voltage	30 Vdc*
Typical 12/24 V thermostat input current	14.6 mA @ 12 V
Nominal 12/24 V generator running B+ voltage	12 Vdc/24 Vdc* = On
Minimum 12/24 V generator running B+ voltage	9.5 Vdc*
Maximum 12/24 V generator running B+ voltage	30 Vdc*
Typical 12/24 V generator running B+ current	14.6 mA @ 12 V
Communication physical layer	2, CAN
Communication protocol	Xanbus
Maximum cable length	130 ft. (40 m)

*Limited to Class 2 levels (100 VA) as in Chapter 2, page 2–5.

Mechanical Specifications

Dimensions	3 ¾ × 5 ¾ × 1 ½ (95.5 × 146 × 37 mm)
Weight	0.5 lb. (225 g)
Mounting	4x #6 screws
Connectors	2x Xanbus: RJ45—8 pins 1x 20-contact pluggable connector (Tyco Mate'n' Lok 2 connector)

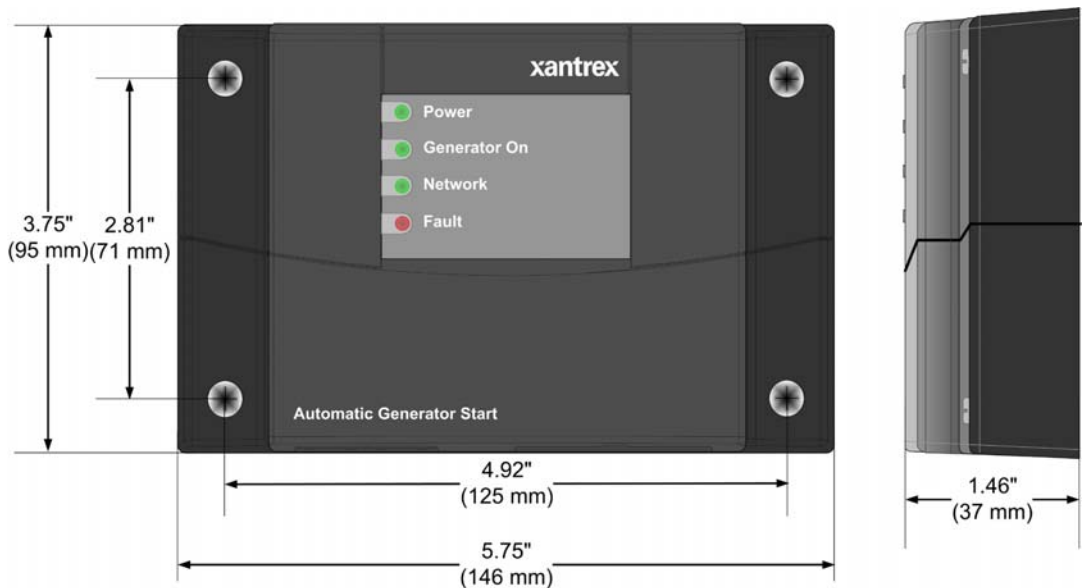

Illustration Not to Scale.

Figure A-1 XW Auto Generator Start Dimensions

Environmental Specifications

Operating temperature	-4 to 122 °F (-20 to 50 °C)
Storage temperature	-40 to 185 °F (-40 to 85 °C)
Maximum case temperature	140 °F (60 °C)
Operating humidity	5 to 95%
Storage humidity	5 to 95%
Ignition protection	None

Regulatory Compliance

Safety	CSA certified to CSA107.1-01 and UL 458 4th Ed. including the Marine Supplement
EMC	FCC part 15B Class B Industry Canada ICES-0003 Class B

B

Generator Auto Start Requirements and Types

Appendix B describes the generator requirements and starting types that can be used with the XW Auto Generator Start.

For this Topic...	See....
“Recommended Features”	page B-2
“Generator Starting Types”	page B-2

Recommended Features

In order for the generator to be automatically started by the XW Auto Generator Start, it must include electric start and an automatic choke. An automatic primer system may also be required on natural gas and propane powered generators. The generator should also include remote start ability with accessible remote start terminals or a connector. Protective systems for low oil pressure, over temperature, starter lockout and over crank control are valuable features that will prevent generator damage and increase system reliability. “Two-wire” start generators are highly recommended because of the greater simplicity for automatic starting and because they are intended for remote/automatic/unattended operation.

Generator Starting Types

The XW Auto Generator Start supports three major generator starting types:

- Two wire
- Three-wire “Onan”
- Three-wire automotive

Note: The terms “two-wire” and “three-wire” refer only to the minimum number of wires necessary to start the generator. Actual installations will require additional wires to connect to the generator, including the generator run signal (switched B+) wiring, and wiring to an optional external ON/OFF switch. For installation wiring diagrams, see page 2–9 to page 2–25.

Note: For overcurrent protection guidelines that apply to the wiring types discussed in this appendix, see page 2–5.

Two Wire

The two-wire type is suitable for generators that are fully automatic. This merely requires two wires to be connected together for the generator to start and run. Separating the wires stops the generator.

Some generators use a momentary two-wire connection for starting and stopping.

Identification

Generators of this type are usually operated with a simple toggle switch or key that turns to on, then off to shut the generator off.

Connection

For this type of generator, the two wires are connected to the normally open and common contacts of Relay 1 (wires 14 and 16). When the AGS receives a command to start the generator, it closes the contacts inside Relay 1, allowing the generator to start. The contacts remain closed for the duration of the generator run and open when the AGS needs the generator to stop.

Three-Wire Onan

The three-wire “Onan” starting type is suitable for generators that are not as automated as the two-wire type. It requires a minimum of three wires: a common wire, a start wire and a stop wire. You may also need to connect the glow plug wires to Relay 1 (wire 14) or Relay 3 (wire 19). If the generator requires independent control of the glow plugs, power may also need to be run to Relay 3 (wire 20).

Identification

Generators of this type are controlled with a three-position switch that is normally in a center (or neutral) position. To start the generator, the switch is pressed and held to the start position until the generator starts. The switch is then released, and it returns to the center position. To stop the generator, the switch is pressed and held to the stop position until the generator stops. Again, releasing the switch returns it to the center position.

Connection

The common wire from the generator should connect to the common connections of both Relay 1 and Relay 2 (wires 16 and 18 respectively). The start wire from the generator connects to the normally open contact of Relay 2 and the generator stop wire connects to the normally open contact of Relay 1.

Three-Wire Automotive

The third generator starting type that is supported by the AGS is similar to an automotive-style ignition. In this style, the generator uses a run circuit that is normally closed, which then receives a momentary start signal. The run circuit remains active throughout the run and then is opened in order for the generator to stop.

Identification

Generators of this type are controlled by a key or rotary switch that acts exactly as an automotive ignition. The switch is first turned to an “on” (or run) position, then further to a start position. After starting, the switch returns to the “on” (or run) position. Other variations are a toggle switch that gets turned on with a separate switch or push button for start. If glow plugs are used, you would turn the key or rotary switch to the left prior to starting. A separate momentary switch or button may be used for this purpose.

Connection

This generator starting type uses the most wires. The common wire from the generator should connect to the common connections of both Relay 1 and Relay 2 (wires 16 and 18 respectively). You may need an additional two wires if glow plugs are used. The start wire from the generator connects to the normally open contact of Relay 2 and the generator stop wire connects to the normally open contact of Relay 1.

C

Relay Timing

Appendix C contains information about relay configuration and timing for each major type of XW Auto Generator Start starting mode. This information applies to each of the generator types described from page 2–9 to page 2–21.

For this Topic....	See....
“RunMode”	page C–2
“MomentaryRun Mode”	page C–3
“GlowStop Mode”	page C–4
“StartStop Mode”	page C–4
“PulseStop Mode”	page C–5

RunMode

For generators with RunMode starting types (Types 7 and 8):

- Relay 1 (RunStop relay) can be used for two-wire configured generators.
- Relay 1 (RunStop) and Relay 2 (Start) can be used with a common ground for three-wire configured generators.
- The Preheat will never overlap the Crank Time.
- The “Delay” refers to the “Preheat to Crank Delay” and may be zero.
- Cranking will cease when the generator run signal goes high for the specified hold time or when the crank time has elapsed.

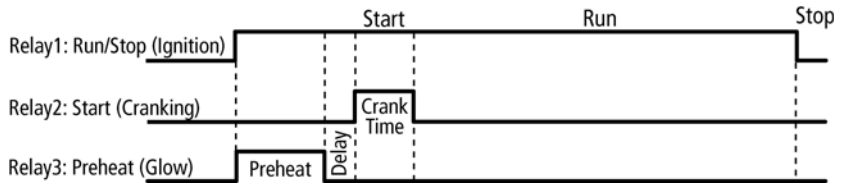

Figure C-1 RunMode Timing Diagram

MomentaryRun Mode

For generators with MomentaryRun mode starting types (Type 11):

- Relay 1 (Run/Stop relay) can be used for two-wire configured generators.
- Relay 2 has no unique function in this configuration, but it is easiest to leave it doing the cranking so that another configuration is not required for it.
- Preheat will generally not be used in this configuration.
- The Preheat will never overlap the Crank Time.
- The “Delay” refers to the “Preheat to Crank Delay” and may be zero.
- Cranking will cease when the generator run signal goes high for the specified hold time or when the crank time has elapsed.

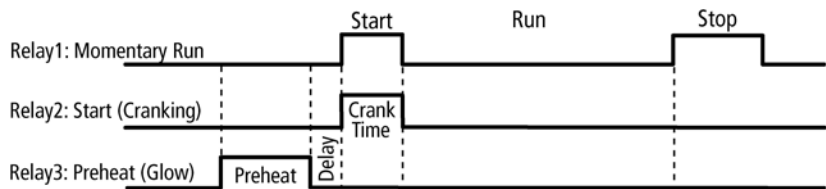

Figure C-2 MomentaryRun Mode Timing Diagram

GlowStop Mode

For generators with GlowStop mode starting types (Types 1, 2, 3, 6, 12):

- Relay 1 (Stop) and Relay 2 (Start) can be used with a common ground for three-wire configured generators.
- The Preheat signal shows up on Relay 1 and also Relay 3 (if enabled) so that Relay 1 can be used for both Preheat and Stop.
- If the ShutDown Bypass is enabled, the Preheat on Relay 1 will remain high for the Crank Time and for the ShutDown Bypass period after cranking.
- The Preheat on Relay 3 will only overlap the Crank Time and perform ShutDown Bypass if Relay 3 is configured for Preheat with ShutDown Bypass.
- The “Delay” refers to the “Preheat to Crank Delay” and may be zero.
- Cranking will cease when the generator run signal goes high for the specified hold time or when the crank time has elapsed.

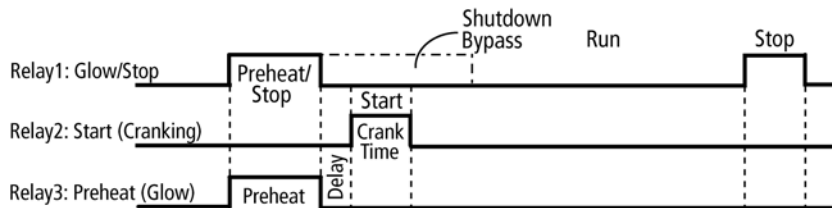

Figure C-3 GlowStop Mode Timing Diagram

StartStop Mode

For generators with StartStop mode starting types (Types 4, 5, 9, 10):

- Relay 1 (Stop) and Relay 2 (Start) can be used with a common ground for three-wire configured generators.
- If Relay 3 is configured for preheat, the signal only shows up on Relay 3.
- The Preheat on Relay 3 will not overlap the Crank Time if ShutDown Bypass is not enabled.
- If the ShutDown Bypass is enabled, the Preheat on Relay 3 will remain high for the Crank Time and for the ShutDown Bypass period after cranking.

- The “Delay” refers to the “Preheat to Crank Delay” and may be zero.
- Cranking will cease when the generator run signal goes high for the specified hold time or when the crank time has elapsed.
- To get the ShutDown Bypass on Relay 3 with no preheat, Relay 3 must be configured for Preheat with ShutDown Bypass and have the Preheat time set to zero.
- StartStop mode is essentially the same as GlowStop mode with no preheat on Relay 1.

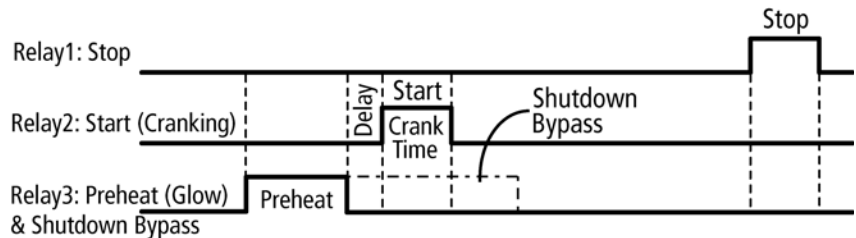

Figure C-4 StartStop Mode Timing Diagram

PulseStop Mode

For generators with PulseStop mode starting types (Type 13):

- Relay 1 (Stop) and Relay 2 (Start) can be used with a common ground for three-wire configured generators.
- If Relay 3 is configured for Preheat, the signal only shows up on Relay 3.
- The Preheat on Relay 3 will not overlap the Crank Time if ShutDown Bypass is not enabled.
- If the ShutDown Bypass is enabled, the Preheat on Relay 3 will remain high for the Crank Time and for the ShutDown Bypass period after cranking.
- The “Delay” refers to the “Preheat to Crank Delay” and may be zero.
- Cranking will cease when the generator run signal goes high for the specified hold time or when the crank time has elapsed.
- To get the ShutDown Bypass on Relay 3 with no preheat, Relay 3 must be configured for Preheat with ShutDown Bypass and have the Preheat time set to zero.

- The XW Auto Generator Start will make three attempts to stop the generator. If the generator has still not stopped at the end of the third attempt, the appropriate Fault will be generated.
- Each stop attempt will consist of engaging the stop relay for 5 seconds and then waiting 20 seconds before checking the state of the Gen Run Signal to see if the stop attempt was successful.

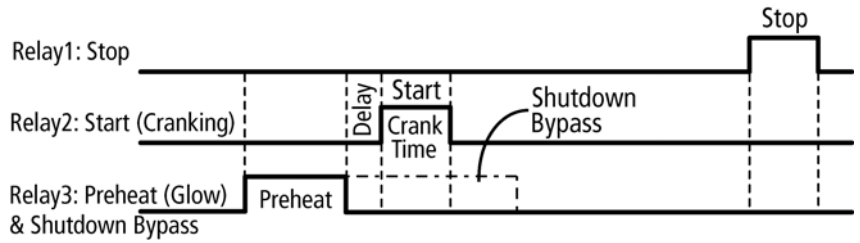

Figure C-5 PulseStop Mode Timing Diagram

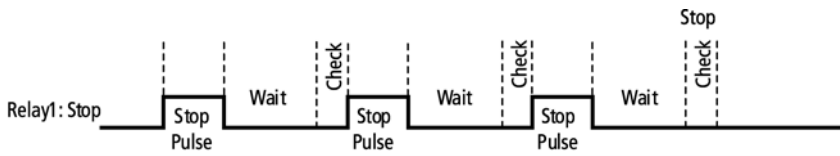

Figure C-6 PulseStop Mode Relay 1 Behavior

Warranty and Return Information

Warranty

What does this warranty cover? This Limited Warranty is provided by Xantrex Technology, Inc. ("Xantrex") and covers defects in workmanship and materials in your XW Automatic Generator Start. This warranty period lasts for 5 years from the date of purchase at the point of sale to you, the original end user customer. You require proof of purchase to make warranty claims.

This Limited Warranty is transferable to subsequent owners but only for the unexpired portion of the Warranty Period. Subsequent owners also require proof of purchase.

What will Xantrex do? Xantrex will, at its option, repair or replace the defective product free of charge, provided that you notify Xantrex of the product defect within the Warranty Period, and provided that Xantrex through inspection establishes the existence of such a defect and that it is covered by this Limited Warranty.

Xantrex will, at its option, use new and/or reconditioned parts in performing warranty repair and building replacement products. Xantrex reserves the right to use parts or products of original or improved design in the repair or replacement. If Xantrex repairs or replaces a product, its warranty continues for the remaining portion of the original Warranty Period or 90 days from the date of the return shipment to the customer, whichever is greater. All replaced products and all parts removed from repaired products become the property of Xantrex.

Xantrex covers both parts and labor necessary to repair the product, and return shipment to the customer via a Xantrex-selected non-expedited surface freight within the contiguous United States and Canada. Alaska and Hawaii are excluded. Contact Xantrex Customer Service for details on freight policy for return shipments outside of the contiguous United States and Canada.

How do you get service? If your product requires troubleshooting or warranty service, contact your merchant. If you are unable to contact your merchant, or the merchant is unable to provide service, contact Xantrex directly at:

Telephone: 1 800 670 0707 (toll free North America)

1 360 925 5097 (direct)

Fax: 1 800 994 7828 (toll free North America)

1 360 925 5143 (direct)

Email: customerservice@xantrex.com

Direct returns may be performed according to the Xantrex Return Material Authorization Policy described in your product manual. For some products, Xantrex maintains a network of regional Authorized Service Centers. Call Xantrex or check our website to see if your product can be repaired at one of these facilities.

What proof of purchase is required? In any warranty claim, dated proof of purchase must accompany the product and the product must not have been disassembled or modified without prior written authorization by Xantrex.

Proof of purchase may be in any one of the following forms:

- The dated purchase receipt from the original purchase of the product at point of sale to the end user, or
- The dated dealer invoice or purchase receipt showing original equipment manufacturer (OEM) status, or
- The dated invoice or purchase receipt showing the product exchanged under warranty

What does this warranty not cover? This Limited Warranty does not cover normal wear and tear of the product or costs related to the removal, installation, or troubleshooting of the customer's electrical systems. This warranty does not apply to and Xantrex will not be responsible for any defect in or damage to:

- a) the product if it has been misused, neglected, improperly installed, physically damaged or altered, either internally or externally, or damaged from improper use or use in an unsuitable environment;
- b) the product if it has been subjected to fire, water, generalized corrosion, biological infestations, or input voltage that creates operating conditions beyond the maximum or minimum limits listed in the Xantrex product specifications including high input voltage from generators and lightning strikes;
- c) the product if repairs have been done to it other than by Xantrex or its authorized service centers (hereafter "ASCs");
- d) the product if it is used as a component part of a product expressly warranted by another manufacturer;
- e) the product if its original identification (trade-mark, serial number) markings have been defaced, altered, or removed.

Disclaimer

Product

THIS LIMITED WARRANTY IS THE SOLE AND EXCLUSIVE WARRANTY PROVIDED BY XANTREX IN CONNECTION WITH YOUR XANTREX PRODUCT AND IS, WHERE PERMITTED BY LAW, IN LIEU OF ALL OTHER WARRANTIES, CONDITIONS, GUARANTEES, REPRESENTATIONS, OBLIGATIONS AND LIABILITIES, EXPRESS OR IMPLIED, STATUTORY OR OTHERWISE IN CONNECTION WITH THE PRODUCT, HOWEVER ARISING (WHETHER BY CONTRACT, TORT, NEGLIGENCE, PRINCIPLES OF MANUFACTURER'S LIABILITY, OPERATION OF LAW, CONDUCT, STATEMENT OR OTHERWISE), INCLUDING WITHOUT RESTRICTION ANY IMPLIED WARRANTY OR CONDITION OF QUALITY, MERCHANTABILITY OR FITNESS FOR A PARTICULAR PURPOSE. ANY IMPLIED WARRANTY OF MERCHANTABILITY OR FITNESS FOR A PARTICULAR PURPOSE TO THE EXTENT REQUIRED UNDER APPLICABLE LAW TO APPLY TO THE PRODUCT SHALL BE LIMITED IN DURATION TO THE PERIOD STIPULATED UNDER THIS LIMITED WARRANTY.

IN NO EVENT WILL XANTREX BE LIABLE FOR ANY SPECIAL, DIRECT, INDIRECT, INCIDENTAL OR CONSEQUENTIAL DAMAGES, LOSSES, COSTS OR EXPENSES HOWEVER ARISING WHETHER IN CONTRACT OR TORT INCLUDING WITHOUT RESTRICTION ANY ECONOMIC LOSSES OF ANY KIND, ANY LOSS OR DAMAGE TO PROPERTY, ANY PERSONAL INJURY, ANY DAMAGE OR INJURY ARISING FROM OR AS A RESULT OF MISUSE OR ABUSE, OR THE INCORRECT INSTALLATION, INTEGRATION OR OPERATION OF THE PRODUCT.

Exclusions

If this product is a consumer product, federal law does not allow an exclusion of implied warranties. To the extent you are entitled to implied warranties under federal law, to the extent permitted by applicable law they are limited to the duration of this Limited Warranty. Some states and provinces do not allow limitations or exclusions on implied warranties or on the duration of an implied warranty or on the limitation or exclusion of incidental or consequential damages, so the above limitation(s) or exclusion(s) may not apply to you. This Limited Warranty gives you specific legal rights. You may have other rights which may vary from state to state or province to province.

Warning: Limitations On Use

Please refer to your product manual for limitations on uses of the product.

SPECIFICALLY, PLEASE NOTE THAT THE XW AUTOMATIC GENERATOR START SHOULD NOT BE USED IN CONNECTION WITH LIFE SUPPORT SYSTEMS OR OTHER MEDICAL EQUIPMENT OR DEVICES. WITHOUT LIMITING THE GENERALITY OF THE FOREGOING, XANTREX MAKES NO REPRESENTATIONS OR WARRANTIES REGARDING THE USE OF THE XANTREX XW AUTOMATIC GENERATOR START IN CONNECTION WITH LIFE SUPPORT SYSTEMS OR OTHER MEDICAL EQUIPMENT OR DEVICES.

Return Material Authorization Policy

Before returning a product directly to Xantrex you must obtain a Return Material Authorization (RMA) number and the correct factory "Ship To" address. Products must also be shipped prepaid. Product shipments will be refused and returned at your expense if they are unauthorized, returned without an RMA number clearly marked on the outside of the shipping box, if they are shipped collect, or if they are shipped to the wrong location.

Warranty and Return

When you contact Xantrex to obtain service, please have your instruction manual ready for reference and be prepared to supply:

- The serial number of your product
- Information about the installation and use of the unit
- Information about the failure and/or reason for the return
- A copy of your dated proof of purchase

Record these details in “Information About Your System” on page WA-5.

Return Procedure

1. Package the unit safely, preferably using the original box and packing materials. Please ensure that your product is shipped fully insured in the original packaging or equivalent. This warranty will not apply where the product is damaged due to improper packaging.
2. Include the following:
 - The RMA number supplied by Xantrex Technology, Inc. clearly marked on the outside of the box.
 - A return address where the unit can be shipped. Post office boxes are not acceptable.
 - A contact telephone number where you can be reached during work hours.
 - A brief description of the problem.
3. Ship the unit prepaid to the address provided by your Xantrex customer service representative.

If you are returning a product from outside of the USA or Canada In addition to the above, you **MUST** include return freight funds and are fully responsible for all documents, duties, tariffs, and deposits.

If you are returning a product to a Xantrex Authorized Service Center (ASC) A Xantrex return material authorization (RMA) number is not required. However, you must contact the ASC prior to returning the product or presenting the unit to verify any return procedures that may apply to that particular facility.

Out of Warranty Service

If the warranty period for your XW Automatic Generator Start has expired, if the unit was damaged by misuse or incorrect installation, if other conditions of the warranty have not been met, or if no dated proof of purchase is available, your product may be serviced or replaced for a flat fee.

To return your XW Automatic Generator Start for out of warranty service, contact Xantrex Customer Service for a Return Material Authorization (RMA) number and follow the other steps outlined in “Return Procedure” on page WA-4.

Payment options such as credit card or money order will be explained by the Customer Service Representative. In cases where the minimum flat fee does not apply, as with incomplete units or units with excessive damage, an additional fee will be charged. If applicable, you will be contacted by Customer Service once your unit has been received.

Information About Your System

As soon as you open your XW Automatic Generator Start package, record the following information and be sure to keep your proof of purchase.

- Serial Number _____
- Purchased From _____
- Purchase Date _____

If you need to contact Customer Service, please record the following details before calling. This information will help our representatives give you better service.

- Other XW Equipment installed
 - XW Inverter Charger Model: _____ Firmware Rev: _____
 - XW Solar Charge Controller Model: _____ Firmware Rev: _____
 - XW System Control panel Firmware Rev: _____
- Length of time XW Auto Generator Start has been installed _____
- Battery/battery bank size _____
- Generator brand/type _____
- DC wiring size and length _____
- Alarm sounding? _____
- Description of indicators on front panel _____
- Appliances operating when problem occurred _____
- Warning or Fault message _____
- Description of problem _____

A

AGS Triggers menu 3-11
automatic mode 3-29

B

B+ wires 2-7
bottom panel features 1-6

C

clearing faults 5-2
Crank Retry Time 3-26
Crank Time 3-25
Customer Service
 preparing to call WA-5

D

Device Info menu 3-30
Down arrow button 3-2

E

electrical specifications A-2
Enable Load 3-18
Enable Temp1 3-18
Enable Temp2 3-18
environmental specifications A-3
Event Log 3-31
Exercise Duration 3-23
Exercise Period 3-22
Exercise Time 3-24
Exit button 3-2
external LED wire 2-7, 2-24
external on/off LED 2-24
external shutdown switch
 connecting to wiring harness 2-22
 input and return 2-7, 2-22

F

Fault light 1-5
Fault Log 3-30
fault messages
 acknowledging 5-2

clearing 5-2
reference table 5-6
front panel features 1-5

G

Gen Type 3-9
generator
 auto start requirements B-1
 type 3-9
Generator On light 1-5
generator run signal 2-7
generator starting modes
 glowstop C-4
 momentary run C-3
 pulsestop C-5
 run C-2
 startstop C-4

I

Information about Your System form WA-5

M

manual off mode 3-30
manual on mode 3-29
Max Run Time 3-22
mechanical specifications A-3
momentary run mode C-3

N

Network light 1-5

P

Power light 1-5
Preheat Time 3-26
proof of purchase WA-5
pulsestop mode C-5
purchase date WA-5

Q

Quiet Time
 Begin 3-8

Enable 3–7
End 3–9

R

regulatory listings A–4
Relay3 3–24
Run Hold Time 3–25
run mode C–2

S

serial number
 recording WA–5
settings
 quiet time 4–4
specifications A–2
Start DC V 3–12
Start Load 3–19
Start Tries 3–26
Starter Cool Down 3–21
startstop mode C–4
StartV
 15min 3–13
 24Hr 3–15
 2Hr 3–14
Stop Absorb 3–16
Stop BattV 3–17
Stop Float 3–16
Stop Load 3–20
switched B+ wires 2–7

T

thermostat
 connecting 2–22
 inputs and returns 2–7, 2–22
thermostats, enabling 3–18
Triggers menu 3–11

U

Up arrow button 3–2
user settings reference table 3–32

V

verifying network power 2–28

W

Warning Log 3–30
warning messages
 acknowledging 5–2
 reference table 5–3
warranty
 out of warranty service WA–4
 terms and conditions WA–1

X

Xanbus 1–3
Xantrex
 web site 1–ii

Xantrex Technology Inc.

1 800 670 0707 Tel toll free NA
1 360 925 5097 Tel direct
1 800 994 7828 Fax toll free NA
1 360 925 5143 Fax direct
customerservice@xantrex.com
www.xantrex.com

975-0307-01-01

Printed in China